

ELECTRONICS AND TELEVISION

& SHORT-WAVE WORLD

FEBRUARY, 1940

1/6

The "SKIATRON"



AN
ENTIRELY NEW
TELEVISION
SYSTEM

Dr. A. H. Rosenthal of the Scophony Laboratories and inventor of the Skiatron system

IMPROVING SHORT-WAVE RECEPTION

THE FIRST
TELEVISION
JOURNAL
IN THE
WORLD

BERNARD
JONES
PUBLICATIONS
LIMITED
LONDON

Electronics

AND
TELEVISION
AND
SHORT-WAVE WORLD

EDITORIAL, ADVERTISING AND PUBLISHING OFFICES
CHANSITOR HOUSE, 37/38, CHANCERY LANE, W.C.1

Editor-in-Chief : BERNARD E. JONES

Editor : H. CORBISHLEY, F.T.S.

Telephone : HOLBORN 6158

Telegrams : BeelaPee, Holb., London

Subscription Rates ; Post Paid to any part of the world—3 months, 5/- ; 6 months 10/- ; 12 months, 20/- . Published monthly, 1/6 net, first day of the month. Proprietors : BERNARD JONES PUBLICATIONS LIMITED.

News and Views

The Television Service

EVENTS have proved that the decision to close down the television service was unjustified. Actually, this decision was made before war broke out and this accounted for the suddenness with which the transmissions were discontinued. The action was taken because it was assumed that enemy aircraft would be able to take bearings by picking up the short-wave signals radiated from Alexandra Palace, and also because when the decision was first made, it was regarded as a luxury service which was costly and was only of benefit to a comparatively small number of people. As events have shown, because of the restriction of general entertainment, television would have been ideal and, without question, there would have been a boom in the sale of receivers. The question that now arises is can the television service justifiably be resumed under war-time conditions?

At the present time there are hundreds of thousands of pounds worth of television receivers lying idle in the hands of the trade and the public, and it is obvious that these receivers, because of the developments which are taking place and are bound to take place in the future in other countries, will become obsolete should the war last any considerable time.

It will be impossible to take up television after the war is over just where we left off, as it is evident from reports of various developments

which have been published in this journal that other countries will have progressed.

Of even greater consequence is the loss to this country of its present lead in an industry which, though now in its infancy, is destined to become of great importance.

During the last European war, the United States captured the film market. A world industry worth probably six hundred million pounds passed largely to the American continent. There is now a grave danger that the same will happen to television, an industry which in the future will probably be equally as important.

We have been at pains to ascertain the views of various authorities on the question as to whether under existing conditions the service could be revived and the unanimous opinion is that a limited service would be most desirable and that there would be but little difficulty in devising safeguards which would prevent enemy aircraft from taking advantage of the transmissions for directional purposes.

Representations have already been made to the defence authorities, the Television Advisory Committee and the Postmaster-General, which it is understood are receiving favourable consideration. The difficulties of re-starting the service will, of course, be considerable and it could not be expected that it would have anything like its former elaboration, but during these times of general restriction, this would not really matter and it is easy to visualise an adequate service

entirely without the many trimmings which were part of its former make-up.

German War Inventions

As, presumably, most of the war inventions of Germany are known to the Government, there does not appear to be an adequate reason why precise details should not be published. At present the work of devising means of countering these devices rests with a comparatively small body of experts who, although possessing great ability and knowledge, cannot be said to represent the entire inventive genius available.

Among the readers of the technical Press of this country, and in fact the world, there are many who have highly specialised knowledge which could be brought to bear on various problems if exact data were available.

Many more or less imaginative descriptions of the magnetic mine, written by lay-journalists, have appeared in the Press, but such information (?) as this is, of course, utterly useless, and perhaps misleading to the trained technician. Provide him with the precise data, however, and he will tackle the problem in real earnest. In the case of the magnetic mine, the Germans have been told that we are aware of its construction and that effective counter measures have been devised. This does not necessarily mean that these measures are the best possible, but, assuredly, the latter would be forthcoming were the problem put to the whole trained brains of the country. The complexity of the problems would suffice to prevent an influx of futile suggestions if the authorities have any concern in this respect.

THE SKIATRON—A New Scophony Development Towards Large-screen Television Projection

CINEMATOGRAPH TECHNIQUE MADE AVAILABLE TO TELEVISION PROJECTION IN OPTICAL STORAGE SYSTEM THROUGH USE OF ELECTRON OPACITY EFFECTS

By *A. H. Rosenthal, Ph.D., F.R.A.S., A.M.I.R.E., of the Scophony Laboratories*

The technical stage reached in the development of television receivers may be summed up somewhat as follows: The direct viewing cathode-ray tube—a tube where the picture is built up on the fluorescent screen at its end—is giving satisfactory pictures of good definition and adequate brightness for pictures up to approximately 10-12 inches or so. There is no doubt whatsoever that with the growth of television the demand for much larger pictures, pictures which can compare in size, quality and appearance with home cinema pictures, will be more apparent. Home pictures projected from small-size cathode-ray tubes through an optical system have been demonstrated, but results so far have not been too satisfactory, such projected cathode-ray tube pictures leaving a lot to be desired, both in brightness and in picture appearance. Apart from cinema screen television, Scophony have produced by means of their mechanical optical scanning methods projected pictures in three sizes for the home, namely 18 in. by 14 in., 24 in. by 20 in., and 4 ft. by 3 ft., which were demonstrated just before the outbreak of the war. In their search for large projected pictures, Scophony have actually effected an important development in television reception by the invention of the Supersonic Light Control, which was the first practical means of "storing" picture signals and of projecting a series of picture elements simultaneously. This is an advantage which is absent in receivers using cathode-ray tubes.

Scophony felt that the future of television reception lies in the expansion of the principle of storage. The next development described in this article by its inventor, Dr. Rosenthal, of the Scophony Laboratories, makes use of storage over the whole of the picture. Theoretically, it represents the ultimate ideal.

IT is generally recognised that the future of television, its cultural and commercial importance, its value for entertainment and propaganda, depend to a great extent upon the development of a television system which is able to provide pictures of any desired size and brightness in a way as simple and efficient as realised in the technique of the cinema. What is the common characteristic feature in cinematography which makes it possible to build small home projectors for a picture size of a few feet, as well as the biggest theatre projectors, providing pictures large and bright enough to be viewed by thousands of people? It is the principle of the *optical projection* of successive pictures of varying transparency, whereby each picture is *retained* for a certain time and projected as a whole by a *standard* light source on to the viewing screen. Translated into the language of television technique: It is the principle of *light control* combined with *optical storage*.

The production of pictures by light control methods means the use of a standard light source, i.e., an incandescent—or an arc lamp, to illuminate the viewing screen, and the modulation of the light intensity values of the various picture elements, *simultaneously* by the varying transparency values of the film picture in the case of cinematography,

or *successively* by a light modulator actuated by the received signal in the case of television. In both cases the total light flux available, and therewith the possible size and brightness of the picture depend mainly upon the brightness of the light source used and upon the apertures of the projecting optics.

The chief advantage—from the point of view of the optical efficiency—of a film projector over a television projector is essentially the advantage of *simultaneous* over *successive* projection

of the picture elements. The link between these two methods of projection is provided by the principle of *optical storage*, by which a number of the *successively* arriving picture signals corresponding to the individual picture elements are stored in the form of variations of some optical property side by side on a carrier, in which form they can be *simultaneously*—and lasting for a certain time interval—projected.

The well known successes of the *Scophony television system* based on

The apparatus used by Dr. Rosenthal in the development of the Skiatron system.

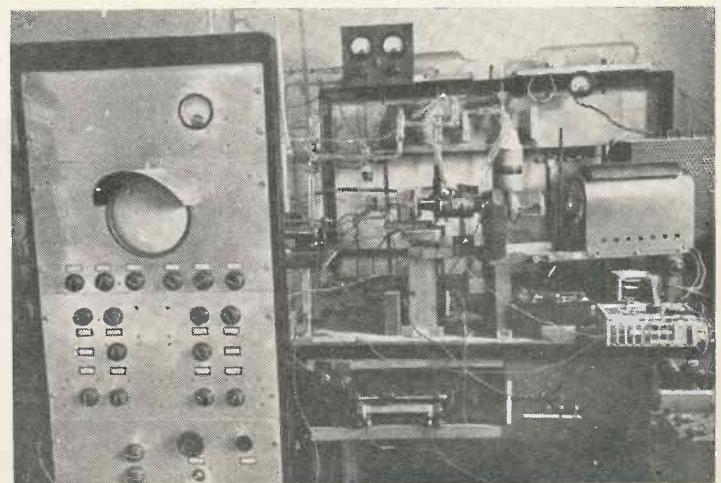

The New Principle

mechanical-optical principles, to provide pictures of cinema standard, were obtained by the optical storage of several hundred picture elements on a carrier of supersonic waves in the *Scophony light control*.

The most direct attempt to employ the advantage of the *full optical storage* of cinematographic technique to television has been the *intermediate-film method*. Here the television signals are photographically recorded as small film pictures on a cinema film as a carrier which can be projected by a standard cinema projector. But apart from a considerable and objectionable time lag between recording and projection of the images, caused by the necessary processing of the film, the system is very uneconomical by reason of the large amounts of film consumed.

A promising variation of this method, consisting of the use of an endless film, from which the pictures can be removed after having been projected and which can then be recoated with emulsion, is so complicated that no practical results could be obtained. Yet, if the received television signals could be recorded in a directly visible, i.e., projectable form on a carrier, and, more than that, if these recorded pictures could be retained on this carrier just for the duration of the picture repetition—or frame period during which they can be projected, and then, after having served their purpose, could be removed and replaced by a record of the following picture, all the drawbacks of the intermediate-film method would have been overcome, and an ideal system of television projection would result.

Optical Variation

What means does physical science offer towards the attainment of such an ideal solution of large screen television?

It is obvious that the received signals, in order to be recorded on the picture carrier screen, have to be distributed spacially on this screen, which can best be done by scanning the screen by a *cathode-ray beam* modulated by the signals in the manner usual in cathode-ray tubes. But the screen itself must be influenced by the cathode-ray beam in such a way that a temporary point-to-point variation of its optical qualities results, i.e., a recorded picture which can be projected on to a large screen similar to a film picture.

It has already been proposed to use in a television receiver an image screen, the opacity or the reflecting power of which changes from point to point according to the intensity values of the received picture signals, so that such a screen if viewed directly or imaged by the light from a separate source on to another screen gives a re-

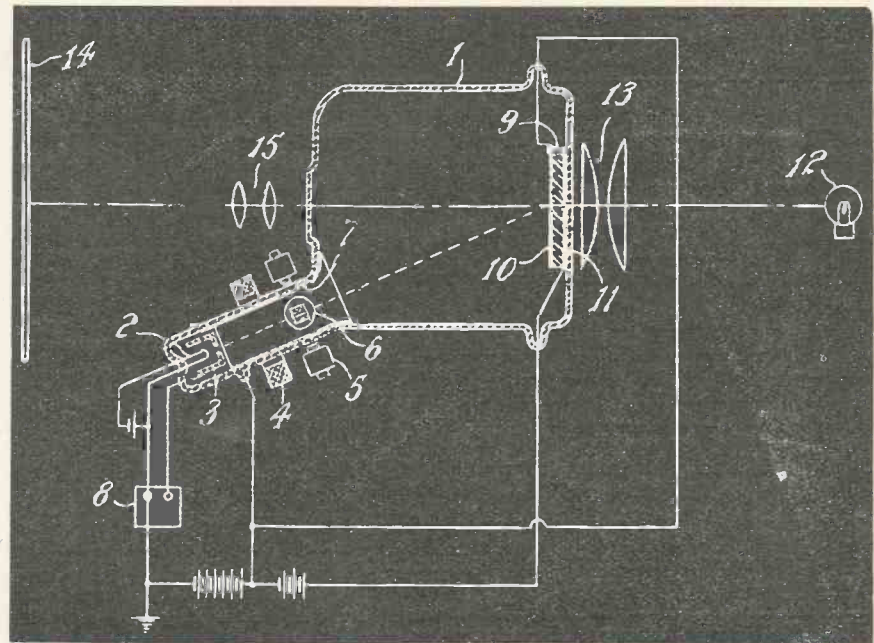

Fig. 1. Diagram showing operating principle of the Skiatron.

presentation of the picture. For such screens it has been proposed to use mechanical shutters, electro-optical or dichroic media and to utilise the orientation effects in colloids and like substances.

But no satisfactory results could be obtained from these proposals.

The most direct and ideal approach towards a solution of our problem would be a screen made of a *material the transparency or opacity of which could be varied by suitable radiations*, as for instance, cathode-rays, and which would retain its varied opacity for a desired period.

Are there materials of such ideal qualities known?

As it frequently happens in the history of applied science, some effect or other has been known as a laboratory curiosity for many years until dragged to the limelight of technical application and usefulness because some technical problem arose for which it seemed to offer just the right solution. To answer the above question: There have been discovered already in the early days of cathode ray research in 1894 by E. Goldstein, and have been known since, such *materials which, normally transparent to visible light, are coloured, i.e., rendered more or less opaque, when they are struck by cathode-rays*. Various scientists investigated later the properties of these materials in all details and found many interesting quantitative relations to other branches of science, for instance to photography, phosphorescence and electron conduction.

Ionic Crystals

Examples of such materials are crystals of the alkali and alkaline earth

halides, such as the chlorides, bromides and iodides of sodium and potassium, lithium bromide, calcium fluoride, and strontium fluoride and chloride. All these crystals belong to the class of the so-called "*ionic crystals*," in which there are electrically positive and negative components, and the forces that hold these components together are of an electric nature, at least in part.

If these crystals, which are normally transparent to visible light, are struck by a beam of cathode rays, X-rays, radium rays or by light of a suitable wavelength, a deposit of opaque material, which is constituted by the so-called "*Farbzentren*" or *colour centres*, is created in these crystals, the degree of opacity depending on the intensity of the incident radiation.

In the case of alkali halide crystals, research has indicated that the colour centres probably consist of neutral alkali atoms which are loosely bound in the interior of the crystals in some manner or other, and which are somewhat similar to the deposit of metallic silver in a latent photographic image. The *deposit of metal in the crystal lattice* can also be created by heating an alkali halide crystal in an atmosphere of the vapour of its alkali metal, which diffuses into the crystal.

Once formed, the opaque deposit can also be destroyed by the above-mentioned rays, the amount of destruction in a given time interval depending upon the intensity of the rays and on the density of the deposit already formed. Thus the gross effect of any given intensity of the incident radiation, being the result of an equilibrium between the formation and destruction of the deposit, may be an increase of the deposit for low intensities and a decrease for the high intensities, in a

How The Skiatron System Works

manner similar to the well-known "solarisation" of the latent photographic image. Thus, over a range of low intensities of the incident radiation, increase in intensity will result in an increase of the deposit, whilst over a range of high intensities an increase in intensity will result in a decrease of the deposit.

The materials exhibiting this property may be defined as ionic crystals in which the injections of electrons into the crystal lattice can produce an opaque deposit, and we may denote this property as *electron-opacity*.

The material may be in the form of a single flat crystal, a mosaic of small crystals, or a micro-crystalline structure. A composite crystal or a mixture of two or more of such crystalline materials may be used.

In most cases, and particularly when the material is in the form of a single crystal, a disappearance of the opaque deposit can be produced by maintaining the crystal in an electric field and at a suitable temperature in which case the deposit is drawn through the crystal towards the positive pole producing the electric field. When it reaches the positive pole it disappears, leaving the crystal substantially transparent. The speed of movement of the deposit depends upon the strength of the field and upon the temperature, and can be varied within wide limits by varying either magnitude. For a given field strength this speed of movement increases with the temperature of the crystal.

Utilising the Effects

There are different possible ways to utilise these most interesting physical effects for the purpose of a television projection apparatus, depending on which of the various forms and modifications mentioned above it, which these effects manifest themselves, we intend to use. Quite generally such a television system comprises scanning an image screen including a material of the type described with a beam of radiant energy modulated in intensity in accordance with the received picture signals.

This scanning produces *periodically* at frame scanning frequency in each elemental area of the screen a *density of opaque deposit* which differs from a fixed datum level of density by an amount depending upon the instantaneous value of the intensity of the beam striking the area. The density of the produced deposit is caused to return to the fixed datum level, whereby the frequency of the return for the successive deposits in said elemental area is equal to the frame scanning frequency.

The datum level of density may be

zero, in which case the scanning beam produces directly an opaque deposit in each elemental area of the image screen proportional in density to the instantaneous intensity of the beam when it strikes the area, and *this deposit is caused to disappear periodically at the frame scanning frequency*.

Alternatively the datum level of density may correspond to picture black, in which case the scanning beam is adapted to remove the deposit from each elemental area to an extent depending upon the instantaneous intensity of the beam when it strikes the area, and the density of the deposit in each elemental area is caused to return to a maximum value corresponding to picture black periodically at frame scanning frequency.

All the various forms and operation which are fully described in the British Patents Nos. 513,776, 514,155 and 514,776 and further applications, need not be dealt with here. Following are some examples which reveal most clearly the principle of the device or on which most experimental evidence has been collected.

Referring to Fig. 1 a cathode-ray tube 1 is provided with a cathode 2, a control grid 3, a beam focusing coil 4, deflecting coils 5, 6 and an accelerating anode 7. Picture signals from the receiver 8 are applied between the cathode and control grid in such a way that the positive potential of the grid decreases with increase in signal strength, so that a modulated beam is produced and is swept over the image screen in the usual manner.

The image screen consists of a flat crystal 9 of an alkali halide such as potassium chloride, provided on each side with an electrode 10, 11 designed to permit the passage of light. These electrodes are shown in the form of thin transparent sputtered metallic layers, but they can also be in the form of fine meshes or the like. The potential of the electrode 11 is maintained positive with respect to that of the electrode 10 to provide an electric field in the crystal. The crystal 9 is traversed by light from the incandescent lamp 12 which is concentrated on the projection lens 15 by the optical condenser 13, and an image of the crystal is formed on the projection screen 14 by means of the projection lens 15.

How the System Functions

The apparatus operates as follows:

On striking a given elemental area of the crystal 9, the modulated cathode-ray beam produces therein an opaque deposit of a density proportional to the instantaneous intensity of the beam. After the beam leaves this area the de-

posit persists and moves through the crystal in the direction of its thickness towards the more positive electrode 11, where it disappears.

This phenomenon can be explained by assuming that the incident cathode-ray beam injects into the elemental area of the crystal a number of electrons corresponding to the instantaneous intensity of the beam when it strikes the area. These tend to travel as free electrons towards the positive electrode between the crystal lattice, which is composed of alternate positive alkali ions and negative halogen ions. During this travel certain electrons will be captured by the alkali ions, which have a great electron affinity.

An alkali ion and an electron together form an electrically neutral metallic alkali atom which constitutes the above-mentioned colour centre, and thus *the position of each captured electron is made visible as a colour centre*.

The impinging electrons of the cathode-ray beam may release secondary electrons in greater numbers on their impact. These secondary electrons also tend to travel inside the crystal lattice, thus increasing the effect. Some time later, by the heat movement of the lattice (the crystal being held at the necessary temperature) the metallic alkali atom is again split up into an ion and an electron, and the freed electron continues its path through the lattice towards the positive electrode until it is again captured by another alkali ion, forming a visible colour centre nearer to the positive electrode.

Thus the stream of electrons shot into the crystal by the beam and moving towards the positive electrode appears in the form of an opaque deposit constituted by the colour centres and moving through the crystal towards the positive electrode and disappearing there.

The velocity of this opaque deposit is proportional to the electric field strength in the crystal and increases also with an increase in temperature of the crystal.

By a suitable choice of these magnitudes in relation to the thickness of the crystal, it can be arranged that the deposit of a given elemental area traverses the thickness of the crystal in substantially the picture frame scanning period, i.e., during the time interval between two consecutive scanings of the elemental area by the beam. In other words, the frequency of the disappearance of the successive deposits is caused *to be equal to the frame scanning frequency*. The opacity of a given elemental area, which corresponds to the intensity of the beam when it strikes the area will thus remain constant until the beam strikes the area at the next scan, when it will immediately adjust itself to the new value.

Although the deposits produced in a given elemental area must be caused to disappear periodically at substantially frame scanning frequency, the disappearance of one deposit need not coincide exactly with the formation of a new deposit in that area but can occur at slightly later time. This can be achieved by regulating the velocity of the opaque deposit produced in an elemental area by one scan in such a way that it has not quite reached the positive electrode when the succeeding scan reaches the area. Thus any desired slight overlapping may be obtained.

Picture Frequency

From the foregoing it is obvious that the *picture repetition frequency can be much lower* than is usual with normal reception methods since the intensity is held constant during the whole frame period and no flickering occurs. The minimum repetition frequency is now determined only by the demands of the eye in perceiving continuous movement and can be about 17-20 frames per second. This enables a considerable *reduction in the necessary frequency band width* of the transmitted signals to be achieved, or allows with the same band width a *higher definition* to be obtained, or permits of the use of the free part of the band for other purposes. It would further allow a considerable simplification on the transmission side since there would be *no need for interlacing* and a *straight scanning system* could be used. This latter fact is particularly advantageous for film transmitters, which can be made simpler for straight than for interlaced scanning.

It is not essential to have two electrodes as shown for setting up the electric field. The electrode 10 can usually be dispensed with since the cathode-ray

beam striking the surface of the crystal 9 will cause an emission of secondary electrons, thereby setting up an equilibrium potential of a certain fixed value. The electrode 11 is then maintained positive with respect to this equilibrium potential.

In certain cases the electrode 11 can also be dispensed with. For example, if the ratio of secondary electrons ejected from the crystal to primary electrons incident on the crystal is less than 1, the equilibrium potential will approach that of the cathode 2, in which case the potential of the opposite surface of the crystal will be more positive

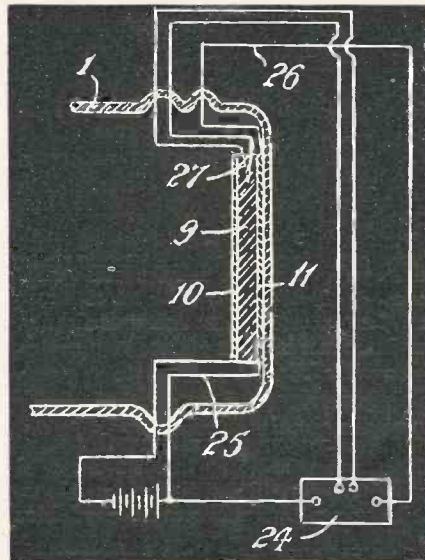

Fig. 2. Method of providing temperature control.

to an extent depending on the leakage resistance between the anode 7 and the end wall of the tube 1. This leakage

resistance may be predetermined by giving to the inner surface of the tube a certain conductivity, for instance, by coating it with a semi-transparent film or rhodium or platinum on a suitable metal oxide. On page 52 is a photograph of the laboratory arrangement of the device with projection tube and optical and electrical components.

Since the velocity of the deposit on its way through the crystal depends on the temperature of the crystal, it is desirable to provide some means of temperature control. In many cases the heat produced by the incident cathode-ray beam, or by the heat rays emitted by the incandescent lamp 12, or by both, will be found sufficient to maintain the crystal at the desired temperature. Where higher temperatures, or a more exact temperature control is required, special means may be provided, an example of which is illustrated in Fig. 2.

The heating can be effected by means of an oven 28, surrounding the crystal 9, and comprising a heating coil 29, fed with current from the source 30, the heating current being controlled by means of the thermocouple 27. The oven is provided with a window 31 to allow the necessary light to illuminate the crystal.

(To be continued next month.)

quency space gained for a finer scanning texture. Du Mont engineers demonstrated a 625-line pattern in comparison with the present 441-line standard.

The Du Mont system makes use of a special trip receiver which automatically follows the transmitter, and does not employ independent sweep circuits at the receiver to produce the scan. In the demonstration the Du Mont special trip receiver reproduced 441 line and 625 line images, without adjustments, as the remote transmitter shifted from one standard to the other. To realise the significance of this it is necessary to appreciate that with the usual system the receiver is necessarily inflexible as it is of course built with certain scanning circuits designed specifically to keep in step with given television standards. Transmitters must necessarily adhere to such standards, for otherwise existing receivers in the field must be replaced or altered to handle any changed transmitting standards.

With the Du Mont system, however, the receiver is a truly universal equipment. It picks up the sync. signals of the transmitter operating on this system, and its oscillators automatically follow the scanning technique chosen at the transmitter.

Improved Television Definition 625-line Scanning and Larger Pictures

DU MONT engineers have developed a new fluorescent screen for television cathode-ray tubes, in which the time lag in the luminous response, supplementing the carry-over optical illusion of persistence of vision, permits cutting the repetitive picture rate drastically without noticeable flicker. Demonstrations were recently given of transmission and reception at just half the usual R.M.A. repetitive rate, or 30 frames or 15 complete interlaced pictures per second. The images, it is stated, appeared as though they were still pictures rather than a pictorial weaving of a successive series of luminous lines.

Halving the picture frequency

means that the transmitting frequency channel can likewise be halved and two television channels be made available where but a single one existed before. However, it is proposed to use the extra room thus gained for an increased number of scanning lines, so as to increase the picture detail, which feature is highly desirable as the art progresses towards larger screen images.

With the present R.M.A. (U.S.A.) 441-line 60-fields-per-second standard, an increase in the number of scanning lines is out of the question within established channel widths. The Du Mont persistence screen, however, it is claimed, cuts down the frame frequency and utilises the fre-

THE IGNITRON

—A NEW MERCURY-VAPOUR RECTIFIER

By *H. De B. Knight, B.Sc., M.I.E.E., F.Inst.P., of The British Thomson-Houston Research Laboratories*

THE Ignitron is a mercury vapour arc rectifier in which the arc is started by means of a special igniter and without any moving parts. The igniter enables precise control of the arc to be obtained, a feature which, together with the known ability of the mercury rectifier to give very high peak currents, makes it particularly suitable for the control of resistance welding equipments. In addition, it has a low voltage drop and hence a high efficiency.

Two ignitrons of B.T.H. manufacture are shown in Figs. 1, 2 and 3. The type BK22 has a glass envelope, and the illustration shows the mercury pool cathode, the anode, and the igniter attached to a side arm. The type BK23 ignitron has a steel envelope and is water-cooled. The electrodes and general arrangement are similar to those in the type BK22, and are clearly visible in Fig. 3. Cooling water passes through the annular chamber between the outer jacket and the vacuum envelope, and enables the type BK24 ignitron to carry much

heavier currents than the type BK22, in spite of the smaller dimensions and closer electrode spacing.

In its application to resistance welding, the ignitron is connected in the A.C. supply line to the primary of the welding transformer, as shown in Fig. 4. Generally two ignitrons are used, as shown, in inverse parallel connection, to pass both halves of the A.C. wave. The ignitrons act as a precise and practically inertia-less switch.

As in the conventional type of mercury rectifier, the ignitron may have two or more anodes; but single anode ignitrons are more usual, partly because of their extensive use in circuits as shown in Fig. 4, and partly because of their greater flexibility even in polyphase circuits.

Ignition of the Arc

In the arc rectifier the valve action, which causes the current to flow in one direction only, is due to the difference in thermal and electrical conditions at the two electrodes, the conditions at the cathode favouring the emission of electrons.

Rectifier types differ according to the kinds of cathode employed, and to the methods used for producing the conditions required for electron emission. In rectifiers having a mercury pool cathode the electron emission takes place from the bright cathode spot which is visible on the mercury surface.

The difference between the ignitron and the usual type of mercury rectifier lies in the method of producing the cathode spot. In the latter an ignitron electrode is momentarily dipped into the cathode and then withdrawn, breaking an electric circuit and forming a small arc with the required cathode spot on the mercury. If the anode is at the necessary positive potential an arc forms between it and the cathode spot, thus giving rise to a unidirectional current in the main circuit.

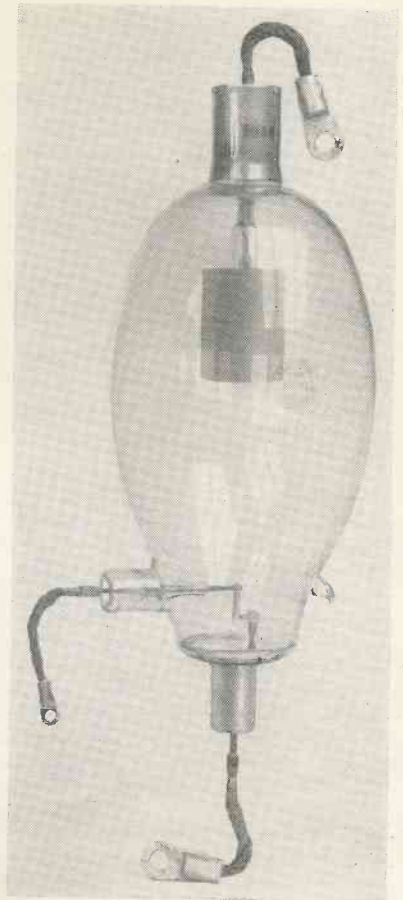

Fig. 1. Type BK22 Ignitron (diameter 7½ in.).

In the case of the ignitron, however, the "igniter" electrode is stationary and is permanently immersed in the mercury pool; there are no moving parts. The required cathode spot is produced by passing a current through the igniter and the mercury from an auxiliary circuit. A small cathode spot forms at the junction of the igniter with the mercury surface, and an arc flows to this spot from the main anode if the latter is at a suitable positive potential.

The igniter itself is a rod of semi-conducting material, such as a carbide of silicon, tungsten, or boron, or a mixture of graphite and clay. It is designed to produce the cathode spot with the lowest possible igniter current, consistent with reliability and mechanical strength.

In practice the power required in the igniter circuit is very small, because although the current may have a peak value of 10 amperes or more its duration need be only a very small fraction of the cycle. When the necessary arc current is established, the cathode spot is formed within a few microseconds, and the main arc strikes to it within less than 100

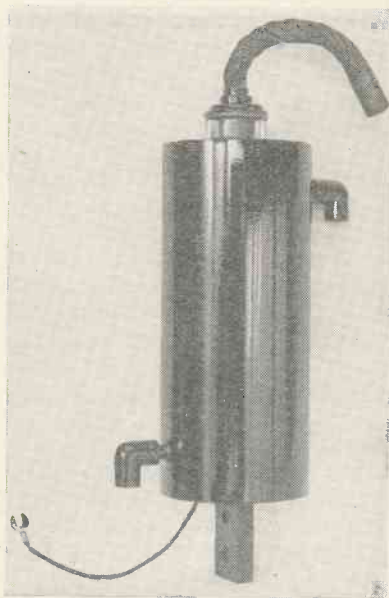

Fig. 2 Type BK24 steel Ignitron (diameter 4 in.).



Fig. 3. Type BK24 Ignitron cut away to show general arrangement.

micro-seconds, the time depending on the anode potential. In the usual circuit, as shown in Fig. 5, the igniter is supplied in parallel with the anode. When the main arc strikes, it short-circuits the igniter circuit and the igniter current falls to zero. The duration of the latter, therefore, is of the order of 100 micro-seconds or less, and its mean value may be less than one ampere.

As the igniter current itself should be unidirectional, it is generally supplied through a hot cathode thyatron. A minute amount of controlling power supplied to the grid of the thyatron causes an igniter current to flow, thus establishing the arc in the main circuit. This makes possible the precise control of the highest power welding machines.

Theory of Operation of the Igniter

When the current passes through the igniter and the mercury, a minute cathode spot appears at the junction of the two. An arc forms to this spot first from the upper end of the igniter, which is thus short-circuited; and then the main arc ignites if the anode potential is sufficiently positive.

Two separate theories have been

advanced to explain the formation of the initial cathode spot. According to the theory of J. Slepian and L. R. Ludwig¹, the effect is due to the high potential gradient present at the point where the igniter enters the mercury, due to the concentration of the lines of current flow at this point. The gradient is believed to be sufficient to drag electrons out of the cathode, by the field effect described by Langmuir.

A different theory has been suggested by G. Mierdel² based on the thermal effect at the point of immersion due to the concentration there of lines of current flow. The heat produced is believed to raise the mercury vapour pressure to the value required for the formation of a cathode spot. Mierdel considers that the field available is not sufficient to produce this spot at a cold cathode. On the other hand it may be questioned whether the temperature rise at the point of immersion, and the consequent vapour formation, can be so rapid as to give the precise timing of the arc which is obtainable in practice.

Possibly neither theory alone is sufficient to account for the observed phenomena; and a complete theory may have to take both effects into consideration.

Control of the Arc

In addition to providing a means of producing the cathode spot necessary for the arc, the igniter also provides an ideal means of controlling the arc.

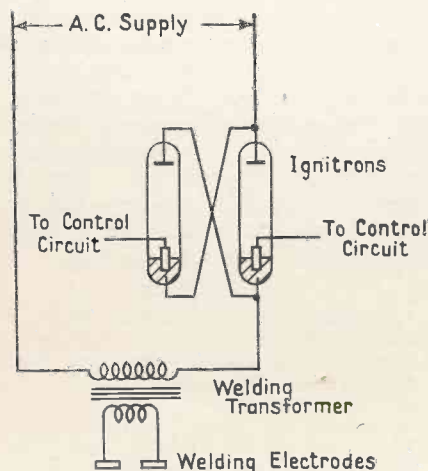

Fig. 4. Schematic diagram of connections of Ignitrons for resistance welding control.

Advantages of the Ignitron

The supply to the anode is generally alternating and the main arc flows only during the half cycles of voltage. When, or soon after, the voltage reverses, the arc ceases, and the cathode spot disappears. There is practically no ionisation present in the ignitron while the anode voltage is passing through the negative half cycle. The igniter, controlled by the thyatron, re-establishes the cathode spot in any positive half cycle in which the main arc is required.

By simple control arrangements in the thyatron grid circuit it is possible to obtain any required series of positive half cycles of current in the main arc. Further, the timing of the ignition is so precise that the arc may be started at any required point in the half cycle. By retarding the striking point it is, therefore, possible to reduce the effective value of the current passed by the arc. This is illustrated in Fig. 6, in which A denotes a predetermined series of current impulses, each composed of three half cycles. By successively retarding the ignition point as in B and C, current impulses are obtained of the same total duration but of reduced effective value.

As already described, there is practically no ionisation in the ignitron when the anode is negative, and there is therefore practically no danger of backfiring; except with high voltages or very heavy currents. In the ordinary mercury rectifier, where the cathode spot is kept continuously alight by an arc from auxiliary anodes, this danger is more serious, and is overcome by increasing the anode-cathode spacing, and by the insertion of baffles. In addition, in such rectifiers, grids must be fitted if the arc is to be controlled. These features not only complicate the design, they also increase the voltage drop—in some cases to more than 50 per cent. higher than in the ignitron—thus reducing efficiency and increasing the heat losses to be dissipated.

A further advantage of the ignitron is that, as the cathode spot is formed afresh every cycle there is no time for the arc to wander to the wall; in other words, the arc is anchored. The cathode therefore need not be insulated from the metal envelope as it is in the usual type of rectifier. This simplifies the construction, especially in the case of water cooled ignitrons.

The advantages of the ignitron may

Ignitron Applications

be summarised as follows:—

1. Low voltage drop and hence high efficiency.
2. Simplicity of construction.
3. Ease of obtaining precise control of output.
4. Flexibility of installation due to the use of single anode units.

Ignitron Ratings

As far as the method of ignition is concerned, there is apparently no limit to the power which can be handled.

The rating varies with the duty for

the arc in every positive half cycle, and its function is to keep the arc alight, rather than to provide a method of timing. This application has not yet been tried extensively. The 3,000 kW 625-volt unit⁶ installed by the G.E. Company for traction service on the New York subway is probably the largest rating ignitron built so far. It has overload capacities of 150 per cent. for two hours, 200 per cent. for five minutes, and 300 per cent. for one minute.

An interesting application for traction substations is the ignitron load-ignition equipment.⁷ This makes use of

⁵ D. Packard and J. H. Hutchings, "Sealed-off Ignitrons for Resistance Welding Control." *G.E. Review*, February, 1937.
⁶ *G.E. Review*, January, 1939, page 15.
⁷ *BTH Activities*, Vol. 14, No. 5, page 181.

A resolution was passed at the annual general meeting of the Radio Manufacturers' Association that the R.M.A. desires to work under the Government "global" allocation scheme for the supply of raw materials for the manufacture of broadcast receiving equipment, and accepts the responsibility for the sub-division amongst individual manufacturers of materials so allocated.

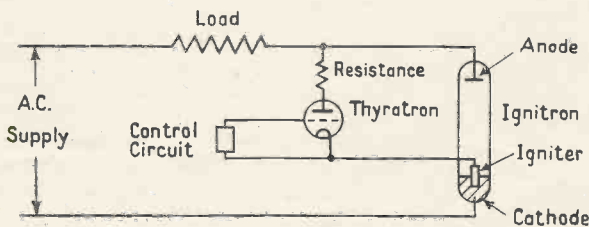

Fig. 5. Ignitron circuit showing method of supplying igniter.

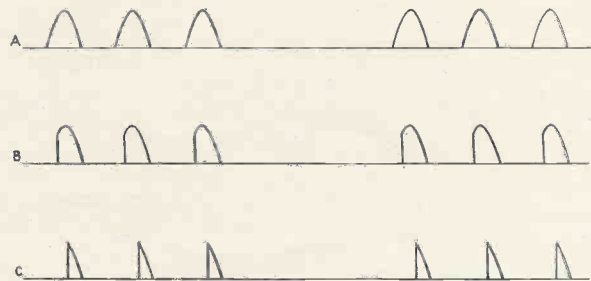

Fig. 6. Variation in current output in ignitron circuit by control of ignition point.

which the ignitron is used. In the case of spot welding at normal speeds, very heavy peak loads may be taken because the average value of the current is low. In seam welding with a high duty cycle the average current is high and the permissible peak current is reduced. The current rating also varies to some extent with the voltage of the circuit in which the ignitron is used.

Ignitron	Type BK 22	Type BK 24
Maximum inverse voltage	900	900 360
Average current rating (amp.)	30	75 50
Peak current rating (amp.)	2500	4000 6000
Welder K16. (2 ignitrons)	750	1250 —

The above table gives representative current ratings of the ignitrons illustrated in Figs. 1 and 2. The last line gives the kVA input to the welding transformer, which can be handled by a pair of these tubes connected as shown in Fig. 4 on a 440 volt A.C. supply under normal spot welding conditions.

Applications

Although we have described its advantages in cases where precision of timing is required, the ignitron is also being applied to ordinary rectification, in which case the igniter starts

the rapid response of the ignitron, enabling loading resistances to be connected across the line within a few milliseconds of the commencement of rise of voltage due to regeneration.

On account of its ability to take very heavy peak currents with accurate timing, the ignitron has found its widest applications in connection with resistance welding. There is a steady growth in the demand for resistance welding equipment, both for speeding up production, and for welding metals such as stainless steel and aluminium and its alloys, which have hitherto presented difficult problems. The demand is for increased welder capacity coupled with simplicity and precision of heat control. Experience both in this country and in America has shown that the ignitron amply fulfils these requirements.

BIBLIOGRAPHY

¹ J. Slepian and L. R. Ludwig, "A New Method of Starting an Arc." *Electrical Engineering*, September, 1933, page 605.
² G. Mierdel, "The Ignition of Mercury Arcs by Internal Igniters." *Wiss. Veroff. Siemens*, Vol. XV, No. 2, page 35.
³ L. R. Ludwig and F. A. Marfield, "An Experimental Ignitron Rectifier." *Electrical Engineering*, January, 1934, page 75.
⁴ A. H. Toepfer, "Low Current Igniters." *Electrical Engineering*, July, 1937, page 810.

This means that if the scheme is carried out the R.M.A. will be responsible for allocating supplies to all manufacturers in the industry, whether or not they are members of the R.M.A.

Summary of other Electronic Patents

(Patent No. 505,529.)

Gas-filled discharge tube or relay of the grid-glow type.—*Akt. Elektrod.*

(Patent No. 506,048.)

Electrode arrangement in a magnetron valve of the sheet-anode type for multiplying high-frequency oscillators.—*Telefunken ges fur drahtlose Telegraphie m.v.h.*

(Patent No. 512,716.)

Mounting a cathode-ray tube in a television cabinet so as to give more convenient access to the various component parts inside the casing.—*Murphy Radió, Limited, and H. F. Wedge.*

(Patent No. 512,519.)

Producing saw-toothed deflecting voltages for scanning from a circuit comprising two valves connected in series, i.e., cathode to anode.—*Baird Television, Ltd., and T. C. Nuttall.*

TELEVISION IN ITALY

SAFAR TELEVISION EQUIPMENT

BY

ARTURO CASTELLANI, INVENTOR OF THE TELEPANTOSCOPE

This article describes the latest developments of Safar, the Italian Radio Company, in the television field. The author, Signor Castellani, is the inventor of the Telepantoscope, which is used in the system described.

ONE of the leading firms in Italy engaged in television development is SAFAR which has devoted many years of research to the production of apparatus which it is claimed, whilst being in many respects of an original type, is not inferior to that used in this country and Germany and U.S.A. Some of the apparatus that has been

the most modern requirements of television technique. In addition, they have installed receivers in Rome in the present exhibition of the Circus Maximus.

The description that follows outlines the particular features of these installations.

The Transmitter in Rome.—The

signal strengths with standard dipoles of the order of 200 uV, which is ample.

Transmission is on 6.8 metres for vision and 7.4 metres for sound, and 441 lines (interlaced) 45 frames per second are used.

The standard of emission which E.I.A.R. has adopted is similar to that in use in England and Germany, i.e., carrier, and the form, length and mixing of the sync. signals are actually those adopted by the German Post Office.

The power of the transmitter is roughly 5 KW for a band width of 6 megacycles, while television requirements have been satisfied within the following limits:—

- (a) Linear frequency distortion contained in - 1.5 db throughout the frequency band 0 - 3 megacycles.
- (b) Phase distortion of 1 microsec. from 25 to 1,000 cycles; of 0.5 microsec. from 0.001 to 1.5 Kg.; and of 0.2 microsec. from 1.5 to 3 megacycles.
- (c) Harmonic distortion from 4 per cent. to 90 per cent. of modulation.
- (d) Hum level of 0.5 per cent. up to 100 per cent. modulation.
- (e) The degree of stability of the frequency is 1 in 200,000.

A block diagram of the layout of the transmitter constructed to the author's design is shown on this page.

The more striking features of the layout are as follows:—

Six high-frequency stages, of which one is a master oscillator stage of 54 metres, stabilised with thermostatically controlled quartz crystal and three one-

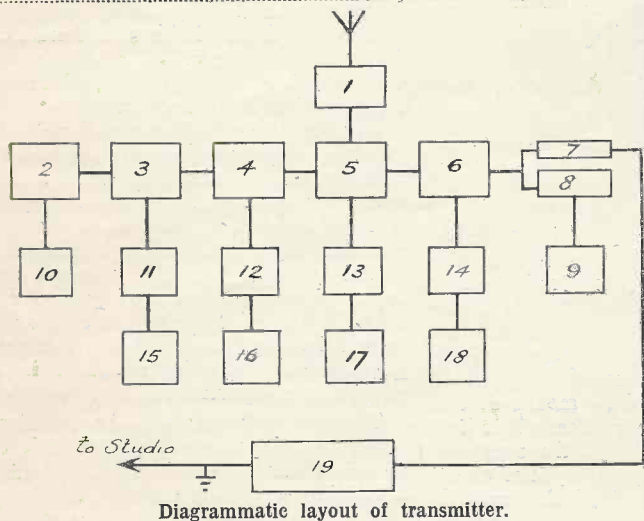

Diagrammatic layout of transmitter.

REFERENCES

- 1. Feeder transformer.
- 2. Amplifier, monitor and frequency multiplier.
- 3. Two 5.5 mc. 11 mc. stages — frequency multiplier 22 mc. 44 mc.
- 4. Fifth H.F. stage — amplifier and modulator.
- 5. Sixth stage: amplifier and modulator.
- 6. Modulating and mixing stage.
- 7. Five stages of amplification.
- 8. Sync. separator.
- 9. Rectifier and sync. separator.
- 10-14. H.T. supplies.
- 15-18. Filters and stabilisers.
- 19. Main control panel.

developed by this concern is of an original type, such as the Telepantoscope, which has already been described in this journal. Laboratories have been equipped for the production of cathode-ray tubes of various types and investigation of different systems of transmission and reception. A number of patents are held by Safar and the concern is independent of monopolies held in other countries.

It was realised that public interest in television and demand for receivers could only be stimulated by the initiation of a regular service, which would give a practical account of the results obtained. The E.I.A.R., therefore, decided to establish a complete television station for the city of Rome and a demonstration equipment in the Leonardo and Italian Inventions Exhibition in Milan. Safar have now supplied a transmitter for the Rome station, and the demonstration gear in Milan which constitutes a complete television layout, conceived and constructed entirely in Italy according to

transmitter is installed on the summit of Monte Mario so that the height of the transmitting dipoles is about 150 metres above the centre of the city. In view of the position of the hill at one side of the city, the radiating system allows of the creation of a more intense field towards Urbe. Reception is, therefore, satisfactory in the whole of the city and its neighbourhood, giving

View of interior of studio.

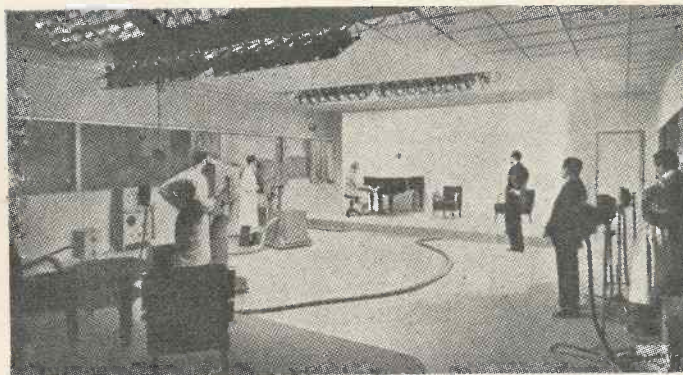

Studio Arrangements

frequency multiplying stages with two amplifying stages following.

Modulation is effected on the grid of the final power stage, operating in class AB₂.

For the video section there are nine stages, of which five are amplifiers operating in Class A, designed for the amplification of the carrier wave at 8.4 Mc. This is already modulated with

The anode and bias voltages are supplied by groups of diode rectifiers, while those for the filament heating are furnished by a rotary convertor group. The anode supply of the video section and the modulated high-frequency stages is provided with stabilisers and filters, which confine the frequency linear distortion within the above-mentioned tolerances.

purpose and sub-divided into several compartments.

The principal compartment is a large central hall fitted with scenery and forming two distinct stages; the studio is provided with illuminating plant using special mobile units containing lamps of medium intensity and adjustable focus projectors, so as to form for the two stages a luminous "ceiling" of uniform distribution without any shadow.

This plant is provided with water-cooled mercury-vapour lamps, placed in series along the sides, so as to leave the area of the scene completely free. The sides, floor and ceiling are constructed of double sound-proof material, and the glass windows at the sides have inclined glasses with corrective angles so that acoustic reverberations are greatly reduced.

Through these windows producers can follow the taking of a scene, the positioning of the cameras and see the reproduction of a receiver.

In view of the high thermal radiation of the lamps and apparatus and the absence of ventilation, due to the special construction of the room, the pavilion has been furnished with an air-conditioning plant with a humidifier.

The two electronic cameras are mounted on wheels. They are connected by a series of co-axial cables contained in flexible metallic tubes with the scanning circuits installed in an adjoining compartment.

These telecameras use the Castellani type B Telepantoscope, of which the mosaic photocathode is characterised by a maximum primary sensitivity due to the accumulation of electrons on the picture element because of the luminous persistence being of the same duration as the picture frequency.

Deflection is of the electro-magnetic type for both directions of scan, while focusing is of the electrostatic type.

The telecameras have been made with

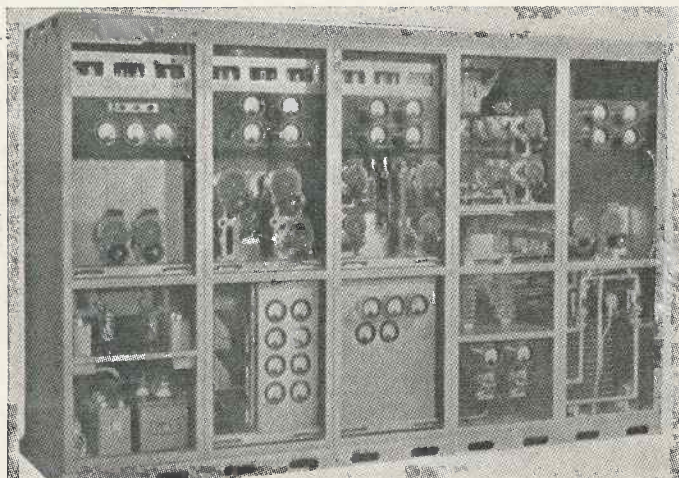

Fig. 2. Part of vision transmitter rack.

the video and synchronising signals in the studio and reaches the transmitter with a maximum amplitude of 1 volt. One demodulating stage is followed by a stage for separating the video signals from those of the synchroniser, one amplifier stage for the synchronising signals and one mixer—modulated stage. All the stages, from the demodulator up, are directly coupled to transmit the D.C. component.

A control oscillograph mounted on a suitable bench monitors the mixed signal on reaching the transmitter, as well as the signal along the whole sequence of stages of the transmitter as far as the aerial circuit.

All valves used in the outfit have been made by Philips in Italy, and it is worthy of note that all these valves are pentodes, including those of the final ultra-short wave stage. This choice was determined by the greater facility for aperiodic neutralisation of the pentode in respect of the triode and by the possibility of it being operated with grid currents much lower than those obtained in triodes of equal power. The former advantage is, in fact, essential in this case for in dealing with neutralisation for a wide frequency band in the triodes, the mutual inductance (of which the impedance is in proportion to the frequency) becomes more and more important from the point of view of reaction, and would necessitate the adoption of neutralising circuits, while on the other hand the starting up would have been rather critical.

The pentodes of the final power stage are of the water-cooled anode type.

The filament supply is suitably filtered and stabilised so as to limit the hum of the values already indicated.

The radiating system, which is shown by the photograph is made up of two blocks of dipoles, one (above) for vision and one (below) for sound.

The dipoles are fed by means of two bifilar lines with a characteristic impedance of 340 ohms. In the construction of the vision dipoles special attention was paid to the feed line and its connection to the transformer and to the dipoles in order to reduce reflections to a minimum.

The Television Theatre in Milan.—As stated, the installation in Milan is for experimental demonstrator and occupies a large pavilion 500 square metres in area, built specially for the

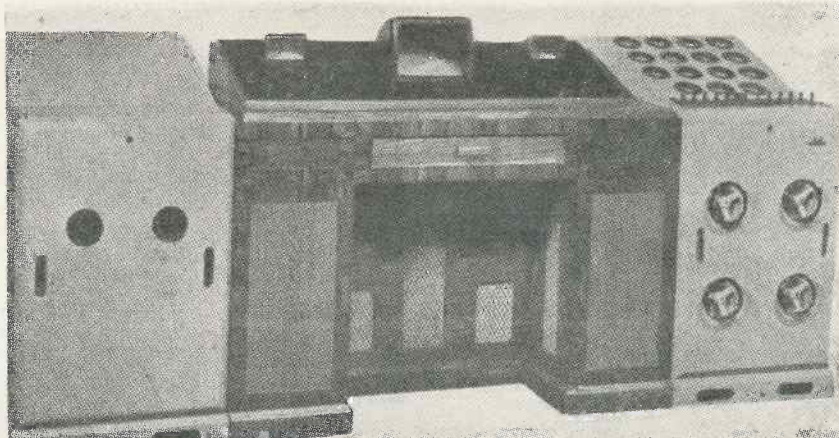
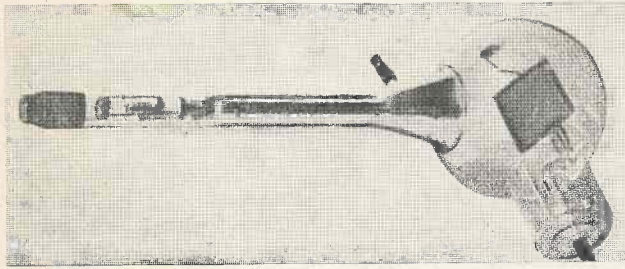

Fig. 3. Front view of monitoring and control desk.



Safar Castellani Telepantoscope type B.

a view to obtaining not only the maximum mechanical, but also optical and electrical mobility and for rapid change of scanning speed. To this end, final deflection circuits for different speeds of scan, as well as the various final compensating circuits for errors of the Telepantoscope, have been arranged at the base of the telecameras.

There are also two primary stages of video frequency amplification as well as the various supplies for the scanning feed.

Simultaneous double "take" is possible which, in the mixing circuits, can give gradual superimposition of two different scenes. For acoustic transmission and mixing, the studio is equipped with directional microphones.

In the compartment adjoining the "take" studio, the video section of the scanning apparatus with all accessories is installed. This unit unites in one single unit, five panels containing the various radio-frequency stages, the amplifying stages for modulation, the feeds, the automatic voltage regulators, the mixer and all the apparatus for drive and control.

Two compartments of the pavilion are reserved for artists and technicians, one for a dressing room and the other a lounge.

Safar Receiver.—As stated before, the latest television receiver made by Safar

is at present in operation in the Leonardo Exhibition in Milan and in the Circus Maximus at Rome.

The degree of technical perfection reached in these receivers represents the culmination of a long period of laboratory research, and they are the starting point for industrial production on a large scale. The new television receiver problems, therefore, are more of an economic and constructive character. The present type of Italian receiver represents the result of 10 years experiments conducted by Safar in the television receiver field with a view to standardisation and low manufacturing cost.

The technical characteristics given in the layout shown as a block diagram can be summed up as follows:—

Amplification at high frequency, mixing and subsequent amplification of the intermediate frequency. The detector output is applied directly to the cathode-ray tube. The input is of the order of about 20 uV. Selectivity in high frequency is 4 Mc. with the point of resonance at 42.5 Mc. so that half the band of the video signal is excluded.

The intermediate frequency employs only half the band (3 Mc) and has the resonance point at 7.4 Mc. All the valves used for high and intermediate frequency amplification are of the high slope type. The sound receiver is of

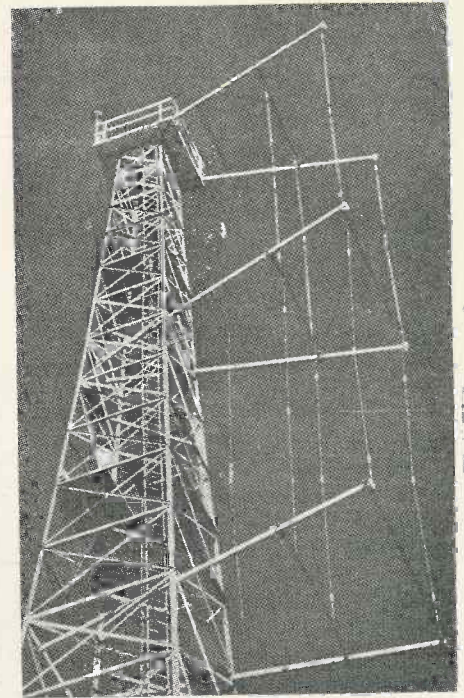

Aerial system of Rome television station.

the normal type and is derived from the mixing and primary intermediate frequency stages. The time bases use a valve for the filter, two synchronisers, and two oscillators, while the feed unit is composed of a rectifier for the anode voltage of the tube (6,000 v) and finally three rectifiers for vision, sound and time base sections respectively.

The cathode-ray tube is of a very short type and has a 40 cm. diameter screen giving pictures 24 by 28 cm. in black-white colour. The bulb of the tube is of pyrex glass and very low curvature of screen has been obtained without risk of implosion. Deflection and focusing are both of the electromagnetic type. The various controls of the receiver are reduced to maximum simplicity and adjustment is very easy.

The production of suitable programmes and the possibility of establishing a network to serve the entire country are now being considered. We are indebted to *Radio e Televisione* for the foregoing particulars.

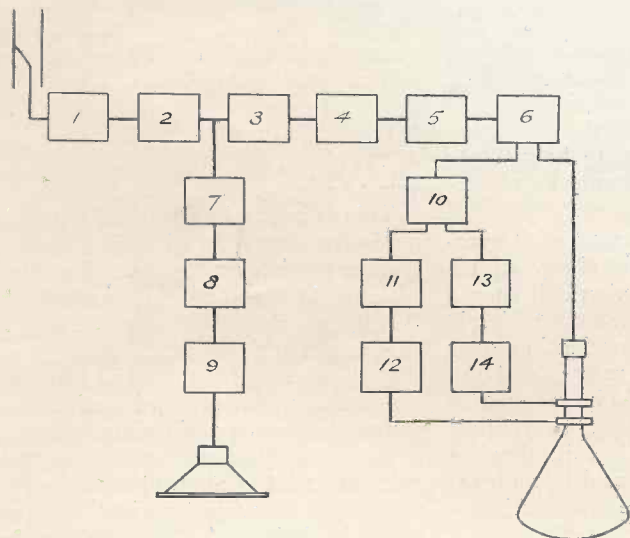

Diagrammatic layout of combined vision and sound receiver.

REFERENCES

- 1. H.F. amplifier.
- 2. Mixer-oscillator.
- 3. {
- 4. { I.F. stages.
- 5. {
- 6. Detector.
- 7. {
- 8. { Sound I.F. stages.
- 9. Power output stage.
- 10. Sync. separator.
- 11. Synchroniser.
- 12. Scanning oscillator (frame).
- 13. Synchroniser.
- 14. Scanning oscillator (line).

"Absolutely Essential"

In a letter to the Chief Editor, Mr. W. W. Burnham, Manager of The Edison Swan Electric Co., Ltd., London, and Chairman of the Radio Manufacturers' Association, says:—

"I think it is absolutely essential that one should have available a résumé on electronic technique which is kept up to date by your monthly journal as one does not have time nowadays to read carefully various publications which were available in pre-war days."

News Brevities—

Commercial and Technical

NEW discoveries in television sound transmission and their application to transcription broadcasting were two of the most important radio engineering developments in 1939, according to the chief engineer of N.B.C.

The introduction of this system, known as the N.B.C. Orthacoustic system, it is claimed, was an outstanding advance. Most of the N.B.C.'s laboratory technicians have been occupied during the past year on television and it was in this connection that the new fidelity method of sound transmission was developed.

The problem, roughly stated, was that of preserving high sound frequencies, as represented by musical notes in the upper registers and harmonics, until they issue from the home loudspeaker. These tend normally either to become very weak or to disappear altogether during transmission. A way to raise the strength of these frequencies was found and so preserve the entire richness of voice or music until it reaches the listener.

A steerable antenna has been installed at the twin station WRCA and WNB1. This is constructed so that the narrow beam of signals which it radiates may be swung across South America and focused on either Buenos Aires or Rio de Janeiro through an angle of 20 degrees merely by touching a push-button.

Stations WRCA and WNB1 operate with 25,000 watts but the new antenna delivers an effective signal of more than 600,000 watts. This arrangement, it is claimed, gives the station a distinct advantage over those of Europe, which have to spread their beams fanwise across the continent at all hours.

The G.E.C. has announced the introduction of four new valves, types Z62, X24, HD24 and KT24. Z62 is a screened pentode primarily intended for ultra-short wave receivers (and television), X24, HD24 and KH24 are 2-volt battery type valves replacing X23, HD23 and KT21 respectively.

Each is of improved design and has lower current consumption with the same high-grade characteristics. In

the X24 the filament current is reduced from 0.3 amp. to 0.1 amp., and in the case of the KT24 the improvement is 0.1 amp., the consumption being 0.2 amp. instead of 0.3 amp. The only alteration in the characteristics of these valves is that the mutual conductance of the KT24 is reduced from 5.3 to 3.2 mA./V.

New York Stock Exchange prices are being broadcast daily by short-wave to the Far East. In stock exchanges in the Orient, including those at Manila, Shanghai and Hong Kong, American and British business men have installed special receiving equipment to hear the latest reports from Wall Street.

The broadcasts are from KGEI, on Treasure Island in San Francisco Bay.

The new development of frequency modulation in the U.S.A. has led to investigation regarding its possible use in television transmissions. It has been concluded that although frequency modulation could not be employed without increasing the width of the required channel many times, owing to the wide band that is necessary, it is possible to employ a relatively narrow frequency swing, of, say, one megacycle. This would not afford the full advantage of noise reduction, but it would have advantages in transmission since the peak power of the transmitter would then coincide with the carrier power instead of being four times as great, as in amplitude modulation. It is thought that, on the whole, the system is feasible, and that it offers certain advantages.

A one-man transmitting station has been produced in U.S.A. The operator is equipped not only with phones, microphone, transmitter and power pack, but also has a vertically polarised doublet aerial strapped to his belt.

The apparatus employs ultra-short waves. The use of ultra-short waves and low power when the apparatus is used for war purposes does much to lessen the likelihood of signals being picked up on enemy receivers.

The American journal *Radio and Television* states that magnetic mines can be exploded by sound and that it is possible to use under-water loudspeakers of special design for this purpose. The statement is made that, with suitable apparatus, it is possible to discharge mines at a distance of almost three-quarters of a mile.

Statistics have been compiled in U.S.A. of the appeal which various types of television broadcasts are producing. Films are very popular and also short variety acts including vaudeville, fashion shows and demonstrations. The quiz show, or unrehearsed *vox pop* programme, where the announcer directs a quiz, a spelling bee or talks to the man on the street, has immense audience appeal. Plays are well received and also all the sporting events—boxing, wrestling, football, hockey, etc., and news stories and events of vital interest which can be seen while they actually are taking place.

The G.E.C. have an ingenious method of checking the insulation of all wire used in their radio receivers. The procedure is to pass the wire through a small mercury bath at a speed of one foot per second. A D.C. potential difference is meanwhile set up across the enamel, i.e., between the mercury bath and the wire. When a part of the wire possessing an enamel fault or "pin-hole" passes through the mercury, current flows through the circuit. The latter includes a sensitive relay and an electric counter which records the number of faults.

The record for the eight months of television broadcasting during 1939 by the N.B.C. of U.S.A. has included over 600 hours of programmes. The schedule has risen from two hours a week to about fifteen, consisting of two programmes daily, five times a week. Of the total, about 30 per cent. consisted of outside programmes relayed by the N.B.C. mobile television station, another 30 per cent. of film and about 40 per cent. of live talent.

Important O.B.'s were the Baer-Nova boxing contest at Yankee Stadium, the Princeton-Columbia baseball game at Baker Field, the football games between Fordham University and Waynesburg College, and the Brooklyn Dodgers and the Philadelphia Eagles.

The mobile television station was fitted with a second camera chain in July, thus increasing its scope for outside news events. New "vest-pocket" portable television equipment, so small that a complete basic unit for wire line transmission could be carried in a taxicab, was added in December.

* * *

The solution of television's most difficult problem in America—that of making it financially self-supporting—is being tackled. N.B.C. co-operated with advertisers in presenting more than twenty-five semi-commercial broadcasts of various types. In these the "sponsor" paid all or part of the talent costs, N.B.C. meeting the expenses of production and overhead.

Several interesting types of commercials were involved during the year. Worthy of mention was the production presented in co-operation with the American Hair Design Institute, a musical comedy transmission in the interests of the Ronson lighter, and the cooking lessons in the interests of Bisquick and Red Barber's "commercials" at the first major league baseball transmission.

* * *

Dr. A. M. Skellett, of Bell Telephone Laboratories, has made a television development to aid astronomers in the study of the sun. The brilliance of the sun prevents astronomers from studying the corona of flaming gas which surrounds the sun itself, except when an eclipse blanks out the brilliant disc. Dr. Skellett's invention makes use of a telescope which projects an image of the sun and corona on to a mirror and scanning disc. The image of the sun is reflected back to a trap, but that of the corona is scanned by means of a mechanical television system. This corona may then be reproduced on a cathode-ray tube and inspected directly or may be photographed.

* * *

The British Kinematograph Society has announced a course of seven refresher lectures entitled "The Theory and Practice of Sound." They will be held at the Pathé Theatre, 111 Wardour Street, London, W.1. The first lecture was on January 26, the subject being "The Theory of Sound," by the President, Mr. A. G. D. West, M.A., B.Sc. They will continue on Friday evenings. The other lecturers include Messrs. P. G. A. H. Voight, B.Sc., A.M.I.E.E.; E. C. Vast, B.Sc.,

D.I.C. (Western Electric Co., Ltd.); L. H. Bacon (British Acoustic Films, Ltd.), and Malcolm V. Hoare. The fee for the course of seven lectures is £1 rs. od. A further course on "Film Production" is being prepared to commence shortly.

* * *

According to a recent article in the *New York Times* the possibilities of the use of television in war are being reviewed by the United States defence authorities. The transmission of television images of enemy terrain from aeroplanes is being considered.

Compact transmitters, known as "jeeps," have been built. The weight is about that of two radio console type receivers and the transmitter can be easily operated by two men. It is stated that although there is some distortion due to vibration from the engines, which occasionally destroys the minor details, the pictures received on the ground are, on the whole, clear.

Not many observation planes are large enough for two extra crew members, but this is not too much of an obstacle, especially if the object of the flight is sufficiently important. Smaller bombers could be used. The chief difficulty, it is thought, will be to provide a system that can overcome interference. Reliable authorities say that this can be done.

* * *

Lord Chatfield, Minister for the Co-ordination of Defence, in the House of Lords, on January 18, said that the scientific talent of this country was fully mobilised to the best and fullest advantage. It included many scientists of the highest status. Each service department and the Air Raids Department of the Ministry of Home Security had its own organisation for considering inventions and passing them to the appropriate department. The Government considered that a central body would hamper rather than hasten matters.

"When I was at the Admiralty," he said, "we were working on television, hoping that we should be able to see the shot falling over the enemy from the bridge of the ship by television. After working on it for some years the scientists produced a television set which would occupy the table in front of me. It produced the goods, but would not go into an aeroplane. We turned it over to commercial work, and that has been a much greater success."

* * *

At the annual general meeting of

the Radio Manufacturers' Association, Mr. C. O. Stanley said that he had strong personal reasons for believing that some sort of a television service would be started in the very near future. It was not right that they should seek to develop a luxury business in war-time, but it was necessary to meet technical and commercial competition from other countries. They had had talks with the G.P.O. and the defence side of the Air Ministry, and he did think that television would come again—although not on a telephone line!

Lt.-Col. Moore-Brabazon said that in the last war the cinema industry had been thrown away to America. He thought there was a need for the continuance of television, for, although luxuries must be curtailed, scientific development must continue.

* * *

The Sterling Cable Co., Ltd., of Enfield, has been acquired by A. C. Cossor, Ltd. Three new directors are Sir Louis Sterling, T. A. Macauley and W. C. T. Cran.

"Overlap and Threshold Howl."

(Continued from page 66)

peated at audio frequency, and the circuit is said to be "squegging." Incidentally, this phenomenon can be utilised to give a self-quenching effect in an ultra-short wave receiver, which would then operate on the super-regenerative principle.

Returning to the question of "threshold howl," it must be remarked that there is no completely satisfactory cure for it, as it can only be overcome at the cost of detector efficiency. The best method, however, is to connect a high resistance, perhaps 10,000 ohms, across the primary of the transformer in the anode circuit, or a higher resistance, of about 100,000 ohms, across the secondary. This disturbs the phase relationships of the current variations and prevents the generation of audio-frequency oscillations, but it also reduces the desired signal amplitude across the transformer. Poor transformers are often the cause of obstinate "threshold howl," and the best solution then is to substitute a transformer of better class.

Even in bad cases where the loss of efficiency seems to be appreciable, the complete prevention of "threshold howl" is usually worth while, as the effective sensitivity and general performance of the set will be improved.

Construction of Apparatus for Recording Sound on Steel Wire

By Ronald L. Mansi, M.R.C.S., L.R.C.P., D.M.R.E. (Camb).

Last month preliminary details were given of the construction of apparatus for recording sound on steel wire and which it is believed are the first, other

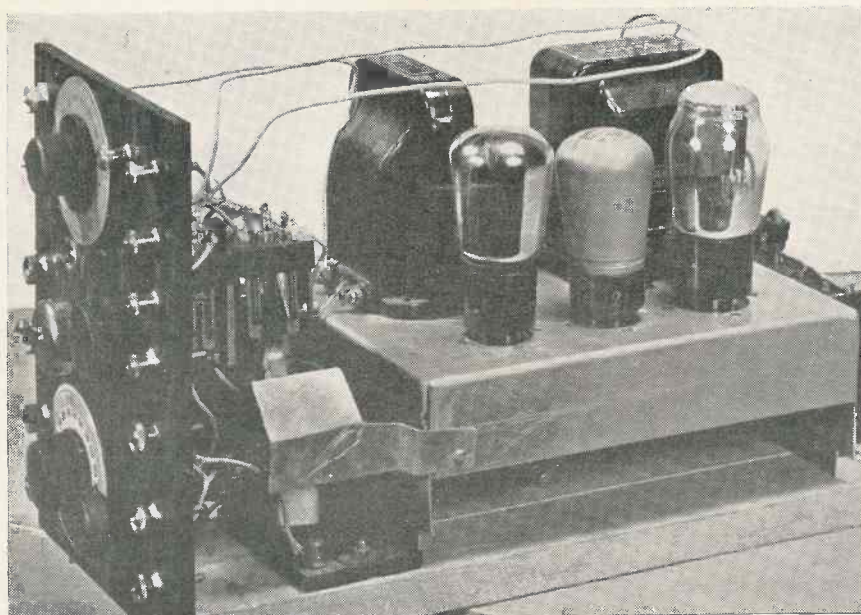

Side view of amplifier with case removed, showing earthed shield over output transformer tapping (see text) and extension on arm of switch contact to make contact with transformer tapping (see text). The first valve is behind the multi-contact switch.

than commercial, ever published. The present article gives actual details of construction of the machine and amplifier.

ALTHOUGH there are many ways of laying out the design for the placing of the various mechanisms of the machine and at the same time obtaining a fair degree of compactness, it was considered by the writer that the prime consideration was accessibility and good visibility of all moving parts for inspection and maintenance. Therefore the layout as shown in Fig. 1 was evolved. This design will especially be appreciated if the operator has the misfortune to overrun a few turns of wire, when they can easily be gathered to-

gether and replaced on the drums which are accessible all round.

As will be seen, most of the various components are mounted as separate units on one baseboard, with the exception of the speedometer which is mounted on the backboard. This eliminates intricate metal castings and supports, etc. It must again be emphasised that there is considerable latitude in this design according to the components available, all the dimensions given here being actually used and intended to be a guide, since they have given satisfactory results.

any maintenance work is necessary on the machine.

No effort should be spared in making this containing box as stout and rigid as possible, since the machine when finished is of considerable weight and it also greatly reduces the slight mechanical noises from the machine.

The bearing surface for the drums (1, Fig. 1) and driving pulley (2) consists of a silver steel rod (3) 12 in. long and $\frac{3}{8}$ in. in diameter. This is very hard wearing, and being already accurately ground needs no machining. It is rigidly clamped at each end with suitable bushes in the little end holes

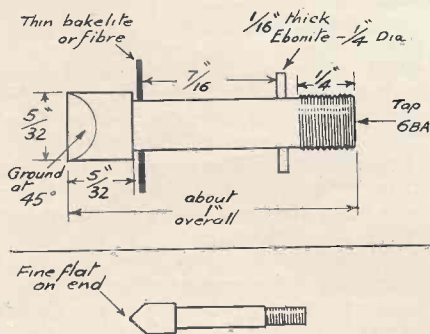

View from above, showing the chisel edge and slight flat at end about $\frac{1}{100}$ " wide

Fig. 5. Dimensional drawing of magnet cores.

The baseboard, triangular side pieces and backboard are of stout laminated wood about $\frac{3}{4}$ in. thick and besides forming part of the containing box provide an extremely rigid foundation for mounting the various components. The remaining half or covering of the box is of somewhat similar shape reversed and hinged to take this portion at the top as shown, so that when closed, the shape is rectangular. It thus opens up and makes for easy accessibility. Provision is made for holding the lid well up out of the way when open and for locking it firmly to the baseboard when shut. In addition the hinges are of strong design with removable pins, so that the lid is soon removed whenever

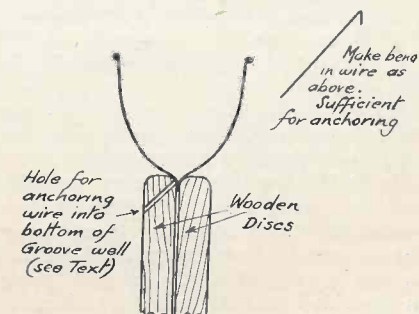

Fig. 6. Sectional view of drum groove showing method of anchoring wire.

Machine Details

of two car type connecting rods (4), the big end caps of which have been removed and the remaining half bolted to the baseboard. This forms an extremely rigid and vibrationless foundation for carrying the drums, etc., and makes for smooth recording. The connecting rods were purchased from a car breaker for a trifle, the height from the baseboard to the centre of the little end hole being 7 in. The drums and the driving pulley revolve freely on the central bar, being prevented from moving sideways along the bar by $\frac{3}{8}$ in. collars and set screws (5). The drive is transmitted to the drums alternately by driving pins (6) cut from $\frac{1}{4}$ in. brass rod, tapped $\frac{1}{4}$ in. Whitworth thread at one end and screwed rigidly into the face of the pulley which is $3\frac{1}{4}$ in. diameter. There are two to each side, placed about $\frac{3}{4}$ in. from the centre of the pulley. Overlapping the ends of these pins by about $\frac{1}{2}$ in. but, of course, on a larger diameter are similar pins screwed into the face of two similar pulleys (7) attached rigidly to the inside face of each drum. The function of these pulleys (7) is to provide an even friction surface for light brake bands to be presently described.

The connecting link between the driving pins is formed by universal joints (8) made of discs of flexible but tough rubber about $\frac{1}{4}$ in. thick, one to each drum. These discs provide a silent drive and allow for any slight irregularities in alignment. Holes are drilled or punched in them to correspond to the pins spaced at right angles and it will be seen that if a disc is slipped along the pins flush up against a drum, that drum will be disconnected from the drive, and if on the other side the disc is slipped towards the driving pulley so that it engages all four pins, then that drum will be driven.

Upon reversing this procedure the other drum will now be driven and the first one be free to unwind in the opposite direction because of the pull of the wire. This manoeuvre is the work of a few moments at the beginning or end of a run and saves the labour of making reversing gear, which is difficult to silence; in addition it allows all the assembly to be accommodated on one shaft.

It should be noted that the driving pulley revolves in the same direction whichever drum is being driven.

A small stop on the end of the driving pins attached to the drums prevents the rubber discs from being shifted too far towards the centre and so coming out of engagement. None is provided on the pins attached to the driving pulley so as to allow the discs to be shifted towards the drums out of engagement when required. No

method of holding the discs in place is necessary as the pressure of the drive will do this, and if the pin holes are drilled slightly undersized, the elasticity of the rubber will hold them in place when out of engagement. The central hole, however, should be drilled well oversized to clear the central steel rod, because if it touches it when revolving, an annoying squeak may result.

The pulleys are of aluminium with a groove $\frac{3}{8}$ in. half round and a boss 1 in. long. Since the driving pulley takes most of the strain of the drive from the motor in one direction, its boss is recessed (in the lathe) and ball bearings fitted, but this is not strictly necessary if a good brass or similar bushing is fitted which is done in this case to the drum pulleys on the assumption that their drive is more regular and even.

Construction of Drums

The drum should not be too heavy otherwise much overrunning will result. The most suitable drum would naturally be of aluminium but with this diameter and depth of groove would have to be specially cast and machined and consequently very expensive. Those in use were built up as follows, the cost being a trifle.

Two ordinary sheet metal tea trays $11\frac{1}{2}$ in. in diameter were placed back to back and sandwiched between two stout plywood discs 9 in. in diameter. (The writer used cheap bread boards for this purpose). The whole assembly was accurately centred, eight holes drilled round the periphery at equal intervals, all burrs removed, and the whole screwed tightly together. The pulley was then centred to the drum with its boss passing through a hole in the drum and screwed rigidly to the drum. The result is a cheap, rigid drum of reasonable weight which will last the life of the machine.

The raised rim of the tea trays forms the groove for the wire, the periphery of the drum being about $1\frac{1}{4}$ in. deep and $1\frac{1}{4}$ in. wide and of a section as shown in Fig. 2. This section will be found to be the most useful in practice, because if it is a true V shape or narrower, the wire has

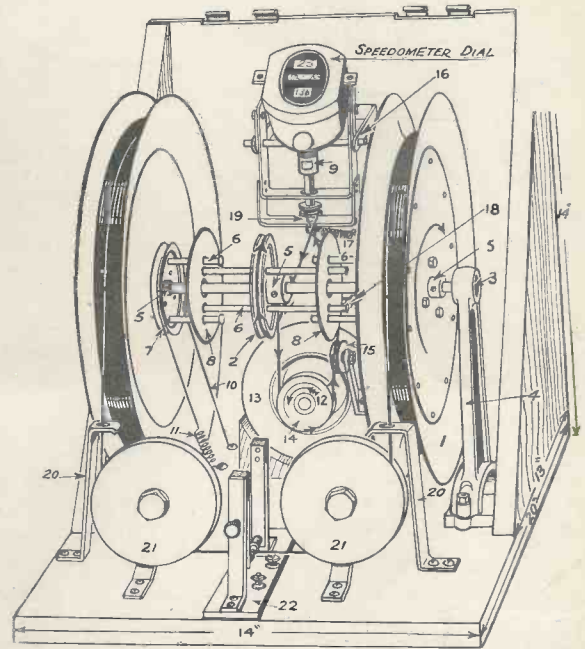

For convenience of reference to the index letters this reduced illustration of the large-scale drawing of the machine given last month is shown.

a tendency to bury and jam itself in the neighbouring turns which press tightly against the sides of the groove and will stop the machine. With this design there is room for the wire to spread sideways and in this respect it should be noted that the wire should never be wound too tightly on a drum because of this danger, but just the lightest of pressure on the brake band of the free drum is necessary. Although the wire may look somewhat loose as a result, it is much safer. This size groove will also be found to accommodate all the wire the constructor is likely to use and still leave a fair amount of side flange projecting, which is necessary to prevent the wire slipping off the drum when being wound on.

The author did at first think that the tea trays, being of ordinary tinned sheet iron (tin plate) might interfere with the magnetic properties of the wire, but having previously tried small drums of aluminium no difference was noted except in the background noise on the first few turns of wire that are in immediate contact with the metal of the rim. In view of the cost of aluminium of this diameter, this may be disregarded, the tin plate in addition being much more rigid than aluminium of the same thickness.

The brake bands (10) perform two functions. They prevent the free drum from overrunning when the machine is stopped, and provide a light but steady tension on the wire as it is wound on and so prevent undue whipping of the wire which might make it jump off the drums or guides, etc. They are sim-

Gauging Speed of Wire

ply made and of such a design that they are self-tightening on the drum that is running free and loosen up when that drum is being driven. One end is anchored to the baseboard, the band then passing over the pulley and fixed to a small tension spring (11) which is in turn fixed to the baseboard with provision for adjusting the tension. The normal direction of the drive on this machine is indicated by the arrow at (12) and so the drag on the band on the driven drum tends to expand the spring (11) and release the tension, the drum then virtually running free of any braking effect.

The drag on the band on the free drum, however, which, of course, is running in the reverse direction tends to assist the action of the spring and so by increasing the tension on the pulley, provides the necessary braking effect. This state of affairs is automatically reversed when the motion is reversed and no manual manipulation is needed. The brake bands are simply lengths of good quality white twine $\frac{1}{16}$ -in. thick; an occasional small spot of oil on them where they contact the pulley prevents them binding in the pulley grooves and ensures consistent action.

Only the lightest of tension will be found necessary, as the recording speed is slow, but if it is required to wind back to the start at a very fast speed, a little increase in tension should be provided on the free drum to prevent mishap with the wire. This is returned to normal tension for recording and playing back.

The Motor and Drive

The motor (13) is situated with its shaft at right angles to the drum axle so that the motor pulley (14) is in line with the rear edge of the drum pulley and so somewhat to the right. This position was decided upon partly for economy in space but mainly because in this situation the magnetic field of the motor interfered least with the pick-up head, and with the iron shields in position on the head this was reduced to nil. Incidentally although the rim of the drums runs in close proximity to the motor, no interference with the recording on the wire was noticed after checking up on this point.

The driving belt is of the same twine as used for the brake bands and follows the rather intricate course indicated by arrows in the diagram as follows:

It starts from the left-hand side of the motor pulley, up over the rear of the drum driving pulley and towards the front. Then down under and rearwards towards the speedometer pulley at the back, which it encircles, and then comes forwards to a small guiding pul-

ley fixed to the top of the motor casing at (15) which guides the belt at right angles back to the right-hand side of the motor pulley.

It will be noted that the speedometer drive is crossed. This was found necessary in order to obtain the correct direction of rotation for this type of speedometer, but it was arranged that, by slightly offsetting the alignment, the two sides of the belt did not touch as they crossed.

It might be thought that this arrangement does not appear very efficient but it should be noted that:—

(1) The various speeds are slow.

(2) No special belting is necessary.

(3) The belt almost completely encircles the drum driving pulley and is self-tightening in action, thus ensuring a good "bite" at the slow speeds. As it crosses and leaves the pulley at right angles the alignment of the belt is slightly "offset" to give clearance. Since this is the heaviest drive in the whole machine, one or two thin ordinary rubber bands running side by side of the belt on the pulley will provide a good grip if the belt slips on starting. Do not let the belt run on the top of them as this will cause the drive to be bumpy and is not necessary, besides soon fraying the rubber.

(4) The speedometer is on a swivel at (16) and held against the drive by a light spring at (17). This ensures a steady drive and "gives" to any momentary irregularities in the drive, such as knots in the belt, sudden starts of motor, etc.

If care is taken in lining up the pulleys correctly to meet the above factors, a perfectly satisfactory, silent, and long-wearing drive will result.

The motor pulley is 2 in. in diameter, the speedometer pulley 1 in. in diameter, and the loose pulley (15) $1\frac{1}{2}$ in. in diameter.

The motor is fixed to the baseboard by a suitable cradle but at all points where it touches the cradle pieces of good thick sorbo rubber (not too tightly compressed) should be interposed to prevent "drumming" and other mechanical noises reaching the baseboard and being amplified by the baseboard acting as a sounding board.

The third brush control (18) projects from the motor casing at the back in an accessible position. The fine control variable resistance is not situated inside the case but is placed outside in a convenient position on the table to which it can be quickly clamped with an ordinary C clamp. This is because it is of the sliding type and could not conveniently be operated inside the machine with the lid closed, but what is more important it was found that when placed inside the casing or in the neighbourhood of the pick-up head, the cur-

rent flowing round the turns of resistance wire (which, of course, is rapidly fluctuating by the commutation of the motor rotor) caused considerable interference which was picked up by the head, more so than that from the motor itself. A distance of about two feet away was found to be enough to eliminate this trouble.

This resistance should be of good quality, wound with thick resistance wire of about four ohms total resistance and capable of carrying about six amperes without overheating, and with an "Off" position.

The current supply is from a 12-volt car-type accumulator which is kept well charged, and the leads of heavy wire enter at the back of the machine to keep them away from the pick-up head for the same reason as the placing of the control resistance.

The Speedometer

The speedometer in use is of the American car type working on the magnetic drag principle, and with the miles per hour figures on a circular drum showing individually through a small window. This type is rather suitable for this machine as it is not so cumbersome as the large circular dial type and the drive comes in at a convenient angle for easy reading.

The drive spindle has the usual squared recess for the end of the flexible drive, which was removed, and a squared split pin $\frac{3}{4}$ in. long was made to be a tight fit in the recess, the last $\frac{3}{8}$ in. of the pin being left round. A cage of strip brass $\frac{1}{8}$ in. thick by $\frac{1}{2}$ in. wide was made to fit to the speedometer casing and this carries the driving pulley and shaft (19). The shaft is lined up to the squared pin and connected to it by a short piece of rubber tubing (9). This provides an excellent universal joint, making up for any slight misalignment and at the same time the thrust of the drive is not borne by the relatively delicate speedometer spindle. As the actual speedometer drive is very light, the rubber tubing is quite adequate for transmitting the torque at all speeds. The tubing should not be too thick walled.

The speedometer pulley is only 1 in. in diameter in order to obtain a sufficient number of revolutions per second to give a fair reading on the dial. It is found that at average recording speed it shows the 25 miles per hour number for speech and the 50 miles per hour number for music. It is very sensitive to slight changes in speed and forms a very useful addition to the machine, especially when, towards the end of a long run, the drums may gradually and almost imperceptibly slow down, due to the battery current falling slightly,

Recorder Construction

in which case the resistance may be adjusted to compensate for this by an occasional look at the speedometer dial.

Of course, on the fast winding-back speeds, it registers the limit at 75 miles per hour and would go up still further if it could. No damage, however, apparently results from this treatment.

If it is found that the red figure (tenths of a mile) on the trip recorder moves up one figure for about every twenty yards of wire. This gives a useful indication of the approximate position of any separate item on the recording or for wiping out certain sections if necessary. Closer approximation is given by watching the position of the figure just moving into or out of the field of vision in its window, a practice soon acquired.

A more accurate yardage indicator would be ideal, but considering the trifling cost of the speedometer no further accuracy will be found necessary in practice.

The trip is returned to zero after each run, and a simple mental subtraction enables the operator to return to any required recording on the wire. A little allowance must be made on a long run for the slight increase or decrease in drum diameter.

The cage is mounted on a strong swivel and fork piece (16) which is screwed to the back board. The tension spring (17) need only be weak since the speedometer drive is light and its only other function, is to take the whip out of the driving belt. The gentle rocking that the speedometer receives aids it in giving a constant reading, being analogous to the finger tap sometimes found necessary on a car to free a sticking meter needle.

The Guide Wheels

The wire is arranged so that it comes off the drums from their front edge for easy accessibility and observation, as shown in the large illustration. It then passes through the guides (20) round the guide wheels (21) which curve the wire at right angles to pass through the head (22). The head is placed in this position at the front of the machine, since it should be the most accessible and easy of inspection of all the units on the baseboard.

The guides (20) are made of stout brass strip $\frac{1}{2}$ in. by $\frac{1}{8}$ in. bent, as shown, the hole in the top being about $\frac{1}{8}$ in. diameter. The purpose of these is not so much to guide the wire as to stop excessive whipping and prevent the wire jumping out of the groove in the guiding wheels (21). The hole should not be too small, as otherwise the wire will saw a slot in side of the hole as the diameter of the wire spool diminishes or increases, thus varying the

angle, and the welds may jam in the slot.

Stout brass is used in the construction of these guides otherwise each guide will vibrate with the wire and defeat its purpose. The end with the hole should be placed as close to the guide wheels as possible to minimise this varying angle of wire relative to the drums.

The guide wheels are $3\frac{1}{2}$ in. diameter so as to form an easy bend for the wire and also to rotate at a reasonable speed. The grooves in the wheels are narrow and deep, namely, $\frac{1}{4}$ in. wide and $\frac{3}{8}$ in. deep with a V section so as to minimise the risk of the wire coming off. The grooves should not be too deep, however, otherwise the varying angle of the wire (for the reasons stated above) may cause the wire to scrape the sides noisily. They are turned from plywood $\frac{3}{8}$ in. thick, the centre hole being bushed with an ordinary $\frac{1}{4}$ in. condenser spindle bushing running free on a short length of $\frac{1}{4}$ in. silver steel rod tapped $\frac{1}{4}$ in. Whitworth at both ends. One end of the rod is capped tightly with a nut and the other end clamped with nuts in a vertical slot (for adjustment) cut in a support of brass strip $\frac{1}{2}$ in. by $\frac{1}{8}$ in. The base of the strip is bent to screw to the baseboard, but not quite at right angles as there is not enough clearance for the wheels to go directly under the drums. They are, therefore, placed forward a little and lean slightly backwards so as to allow the wire to form a truer tangent to the drums when each is half full of wire.

The wheels could be made of non-ferrous metal, but metal wheels have a tendency to "ring" as the wire passes round them. This could, no doubt, be overcome with a little experiment, but rubber rings in the grooves should not be used as the oil on the wire will cause them to rot. Plywood is cheap, strong enough for the job, easy to turn and sound deadening. If, after considerable use, a little warping is noticed due to the oil, they can easily be trued up or a fresh pair made. Further, if they appear to set up a "drumming" in the baseboard due to any inaccuracies in the making, a piece of rubber cut from an old inner tube placed under the base of the support or between the spindle clamping nuts will eliminate it. This rubber damping, however, should not be too resilient otherwise the whole assembly will vibrate with the wire.

Whilst on this subject of silence, it should not be assumed that by mounting the whole machine on rubber feet or felt pads, that further silence will be obtained, since the air space that will then exist under the baseboard will further amplify any noise from the

baseboard. It is found that by having baseboard flat on the table top in contact with it all over its surface, much better damping of noise is obtained.

The method of bushing adopted in the guide wheels is also used in the free pulley (15) and speedometer spindle (19) with suitable washers to take any side thrust friction. The condenser bushes are cheap and easy to replace when worn, the pulley being clamped on by means of a nut on the outside screwed portion of the bush. The $\frac{1}{4}$ in. silver steel rod is accurately ground when bought and will probably last the life time of the machine, all the wear being taken by the bushes.

All bearings should be lubricated occasionally with good quality thick motor oil or better still colloidal graphited oil.

The Recording and Pick-up Head

The recording head is mounted on a base of stout flat ebonite $2\frac{1}{2}$ in. by $5\frac{1}{2}$ in. by $5/16$ in. thick. If not quite flat, it can be made so by warming in an oven and compressed between two true flat surfaces till cold. This is important, as otherwise, when the base is screwed to the baseboard warping may result and throw the head out of adjustment. The chief dimensions are given in Fig. 2 which is approximately scale size. The phosphor bronze strips are rather long so as to exert only light pressure on the wire and, what is more important, so as not to vary the angle of the magnets to any appreciable degree when they come closer together with wear.

The fine adjustment screw also tends to dampen any vibration that may be set up in the spring assembly. The holes in the base of each brass support are slotted to give coarse adjustment and the fine adjustment is provided by the 6 B.A. screws with large heads as in Fig. 2.

Each electro-magnet should be made with the greatest of care as they must match perfectly.

The core of each is a small rod of the finest soft Swedish charcoal iron of the dimensions shown in Fig. 5. It is an added refinement to anneal each core after it is made by making it red hot in a slow fire allowing to cool off very slowly. One end is tapped 6 B.A. for attachment to the phosphor bronze strip and the other end ground to a chisel edge of an angle of about 45° .

It is better to grind this end after assembly on the support as the support acts as a guide in holding it at the correct angle. After grinding the angles, the chisel edge should have a very light finishing flat ground on it about $1/75$ in. to $1/100$ in. wide. This

Recorder Adjustment

ensures that the two chisel edges will be an equal distance apart and parallel for their whole length when separated by the wire. This flat must not be too wide otherwise the magnetic impressions on the wire will overlap or interfere with each other at normal speeds. This can be overcome by higher speeds which, of course, are undesirable. A jeweller's eyeglass is very useful in checking up this operation, and especially when setting the head after assembly.

From the above directions, it will be gathered that the making, assembling and adjusting of the head is one of the most delicate operations in the construction of the whole machine and every care should be taken with it.

Winding the Electro-magnets

A thin bakelite or fibre washer is slipped over the tapped end of the core up to the shoulder and a thicker ebonite washer screwed over the threaded portion so as to leave a space between the two $7/16$ in. wide. The thin front washer should not be of greater diameter than the finished wound coil so as not to foul the two inner guides. One layer of tough paper is wound round the core and then four layers of No. 32 s.w.g. enamelled wire tightly on top. The ends are suitably anchored to the coil, one going to a terminal on the baseboard, and the other to the other bobbin so that the bobbins are connected in series. The cross connection must be well out of the way of the guides and the bobbins connected the right way round as in Fig. 2, otherwise the impulses will cancel each other out instead of being cumulative. A small length of lead is coiled to allow for movement of the electro-magnet, but even these few inches should be measured to match the other side. About three yards will be found necessary for each side but the length should be carefully measured to match up.

Before winding the wire, it is a good plan to pull it tightly through the soft pads of the fingers to remove any irregularities, and it is surprising how many more turns will go into a given space in this way; the object being to get as many turns as possible close to the core. It is for this reason that no other insulation is used save the enamel on the wire, nor is more insulation necessary as the coil does not carry any high voltage. The coil is covered with a suitable protective layer. It may be found necessary to vary the number of turns according to the impedance of the transformer used for best results, but the above is a good average with which to start.

Fig. 7. Diagram showing arrangement of terminals and controls on the amplifier panel.

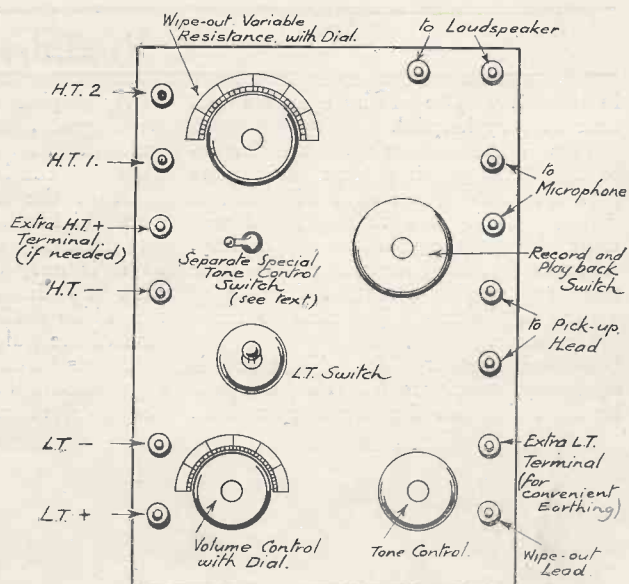

The Guides

The guides may be built up from stout brass strip to the general dimensions shown in Fig. 3. The middle pair may be cut out of the solid, the end pair being cut in the upturned edges of the base piece which is suitably screwed to the ebonite base. The guide wire channels are merely shallow V-shaped notches accurately lined up, the outer pair being a fraction of an inch lower than the middle pair so as to provide just enough angulation horizontally to the wire to keep it seating on all four guides.

The author made the outer pair adjustable for this purpose and for taking up wear, since the outer pair take most of the wear. The notches must not be too deep or narrow otherwise the wire may bind at the welds. About $1/32$ in. deep and a total angle of about 75° at the bottom of the V will be found sufficient, since the object is not so much to guide the wire (the guide wheels do most of this) as to stop the wire "whipping" so close to the head.

The metal should be at least $\frac{1}{8}$ in. thick otherwise the wire will tend to cut into it. Just enough clearance between the two centre guides is necessary to allow for lateral movement of the pole pieces (due to deviation caused by a weld, etc.) about $\frac{1}{8}$ in. each side and the V notches are bevelled so as to ease the entrance and exit of any weld in passing.

It will thus be seen that by slackening the two holding down screws and slipping packing pieces (see Fig. 4) of suitable thickness and material between the brass and ebonite base the whole assembly may be raised to different heights to bring the wire to bear on a fresh spot on the chisel edges of the cores when the previous spot is worn. Packing material should be used that is not easily compressed such as bake-

lite, strip brass, etc. Once a set of these packing pieces has been made they can be changed or added in rotation and no careful re-adjustment will be necessary. About five such positions can be accommodated on the size of pole pieces described as the distance between each new position need only be about $1/32$ in. This type of adjustment was devised to avoid the complication of making an accurate rigid screw type of micrometer adjustment.

To line up the whole head proceed as follows. Thread and arrange the wire as for running the machine but without the motor running. Have the guide assembly in the position in which it holds the wire on the lowest position of the pole pieces. Stretch the wire fairly tightly between the two guide wheels and arrange the height of the whole head assembly so that the wire has the slightest inclination upwards from the guide wheels to the head. Screw the head assembly on its ebonite base firmly in this position. This will provide just the right tension on the wire to stop the "whipping." Subsequent adjustment of the guide assembly upwards will not appreciably alter the angle. Looked at from above, of course, the line up should always be dead straight irrespective of the vertical adjustment.

Magnet Adjustment

With the wire still tightly stretched between the guide wheels, slacken back the fine adjustment till it is out of contact with the phosphor bronze strips. Shift each supporting bracket on the slotted holes till the pole pieces almost touch the wire and then screw down firmly in this position. Now by means of the fine adjustment move each pole piece forward in turn until the barest perceptible sideways movement is seen

Amplifier Details

in the wire. Use of the eyeglass will here be very helpful.

This is the correct pressure for recording and playing back. If more pressure is used, the wire will tend to "sing" as it goes through, and will wear the pole pieces more rapidly. After several long recordings it will be necessary to give a further fraction of a turn to the fine adjustment to make up for wear.

To see whether this adjustment is necessary, gently retract the phosphor bronze strip with the finger tip and on

easily be placed by the side of the electro-magnets, at right angles to the guides and straddling them with a suitable slot cut in the middle to be well clear of the wire and guides. Two such shields will be needed and it is not necessary to shield the whole head as it is only the electro-magnets that pick up interference. The shields should be easily detachable for inspection of the guides, etc., and the correct thickness (usually about a dozen stampings) should be found by trial to suit the interference encountered.

sessions from previously known settings, as a small drop in filament voltage, etc., will greatly affect the recording.

The amplifier may be laid out in any accepted way but care should be used in eliminating any feed back whistle when recording, which is likely to occur on account of the necessary proximity of input and output connections on the one switch.

If a tapped output transformer is used and a different tapping used for recording to that for playing back, it may be found necessary to make a small

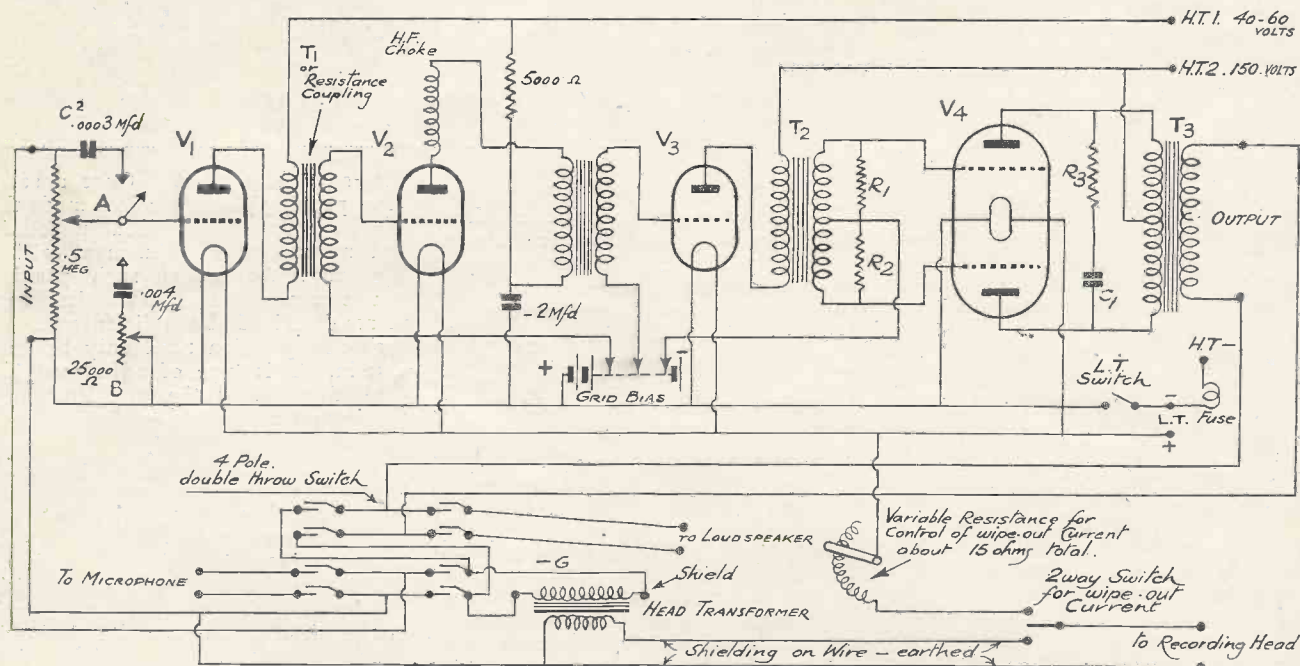

Fig. 8. Circuit diagram of amplifier including switching arrangement.

A—2-way switch for special tone control as described in text. T2—Class-B input transformer. T3—Output transformer to match speaker and head transformer. R1, R2 and R3—10,000 ohms. C1—.005. V1—Any general-purpose detector valve (non-microphonic). V2—Any power-type valve or type as V1 (not super-power). V3—Driver valve. PM2DX (Mullard). V4—Class-B valve. PM2BA (Mullard). (All valves two volt type). No grid bias or decoupling necessary on the first valve. G—If necessary arrange this lead as described in text if separate transformer tapping is used for recording. B—Usual background filter circuit and tone control.

easing it back again watch for the small movement of the wire sideways which shows whether the pole piece is touching it or not and adjust accordingly. After a little experience the trick is soon learned. The chisel edges must, of course, exactly coincide top and bottom.

The small felt pads are attached by a suitable brass clip to the outside guides, the wire passing through them. They should be as small and as neat as possible to avoid unnecessary oil waste and mess.

If found necessary a shield (see Fig. 4), consisting of several large stallo transformer stampings screwed together, may be made so that it may

The Amplifier

All terminals and controls are assembled on one front ebonite panel for ease of inspection. Although not very neat, it enables the operator to keep all connections clean; terminals are used instead of plugs to ensure really tight connections, especially on the filament supply side. To this end, a separate filament switch is mounted in the position shown (Fig. 7) outside on the panel so that its contacts can be regularly inspected and cleaned.

This may appear to be an unnecessary precaution but the sole object is to be able to obtain a consistent strength and quality of recording at different

earthed aluminium shield to fit over the tapping which is not used for recording but for playing back. The transformer used in the amplifier described was of this type and in addition to fitting an earthed shield it was found necessary to eliminate altogether the lead from this tapping to the switch, and instead fit an extension on the switch blade which only made contact directly with the transformer tapping terminal when recording, the transformer being placed in the correct position underneath the switch as shown in the photograph. Earthed shielded wire did not cure the trouble, because of its permanent connection to the ex-

(Continued on page 86)

THE PHOTO-AUGETRON AND ITS APPLICATIONS

By the Technical Staff of Vacuum Science Products, Ltd.

Last month a description and operating principles of the Augetron multi-stage electron multiplier were given. This article describes the photo-multiplier.

READERS of the January issue of this Journal will recall an article describing the thermionic grid-controlled Augetron, which has been developed by Messrs. Vacuum Science Products, Ltd., for use as a voltage amplifier, particularly in high frequency work. In this present article, we shall consider some of the problems involved in the design of photo-electric multipliers and also mention a few typical applications.

The use of the phenomenon of secondary electron emission, in order to obtain amplification of minute photo-electric currents, has now been a fairly common practice for several years. Various types of secondary emission single stage or multi-stage electron multipliers have been developed, mainly for use in connection with television transmission, where very small quantities of modulated light are involved. In fact, it is safe to say that television has only been made possible by means of the photo-electric multiplier, and other complicated vision tubes, all depending for their functioning and efficiency upon the phenomenon of secondary electron emission.

When dealing with very small quantities of light modulated at very high

frequencies, if we attempt to employ the conventional system of photo-electric cell coupled to a multi-valve amplifier, several fundamental difficulties will at once be encountered. In the first place, there is a theoretical limit to the smallness of light quantity that can be employed, since the photo-electric current which has to be passed through the first coupling resistance to modulate the first valve must be large in comparison with the varying noise currents inevitably produced in that resistance, as a result of thermal agitation effects.

Furthermore, with light modulated at the very high frequencies necessary in television transmission, there will, of course, be great difficulty in the design of the initial stages of amplification at the higher frequencies due to capacity troubles in the valves, and their associated circuit components; also, as regards the photo-electric cell itself, only a vacuum cell is possible, since the amplification produced by ionisation in a gas-filled cell, falls away rapidly with rising frequency.

Multipliers for Television

Several types of photo-electric multi-

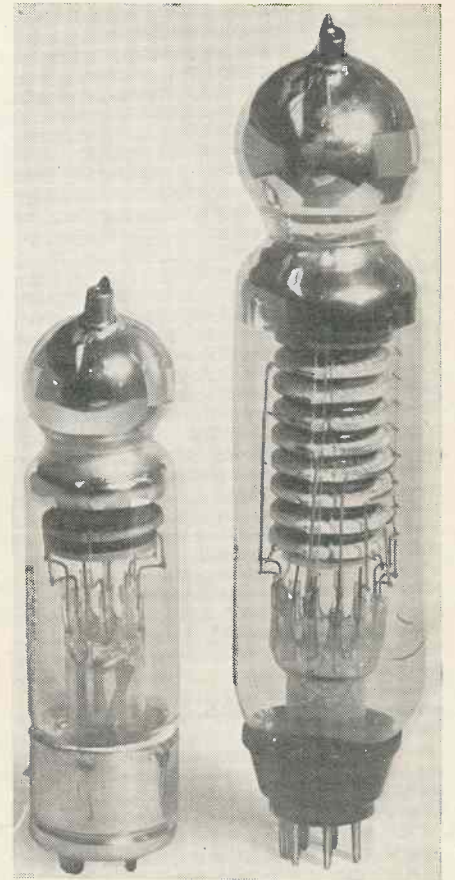

Photograph of two-stage and ten-stage Photo-Augetrons.

pliers have been developed and used in television transmission work, but many of them are subject to criticism on account of unnecessary complexity, either as regards their internal construction or else their associated equipment. In some cases a critically adjusted magnetic field is necessary; in other cases, delicate mesh electrodes can be ruined by excessive current and in other cases, again, a quenching signal must be periodically applied, to avoid damage to the emitters.

The photo Augetron suffers from none of these defects. The electrode assembly is simple and the light receiving cathode may be made of reasonably large dimensions, so that the tube

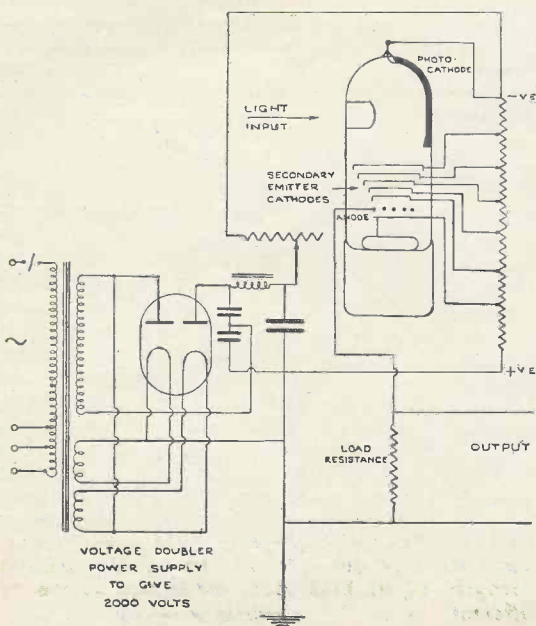

Left: Circuit for six-stage photo-electric multiplier tube.

Below: Demonstration apparatus for modulating a light beam at audio frequency.

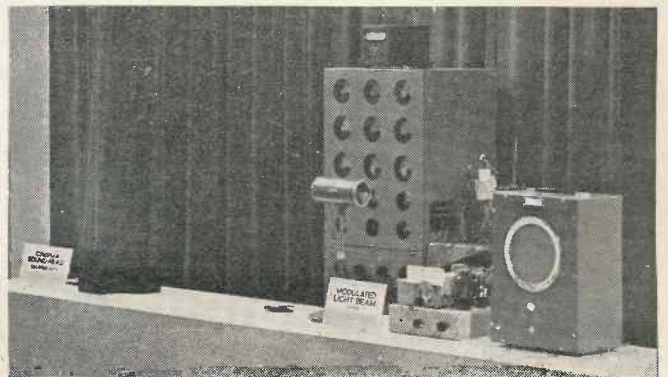

fied. The usual type of regenerative-detector receiver has, however, good regeneration control, and is therefore suitable.

The type of coupling between the superhet input circuit, and the auxiliary reacting stage can be of several kinds. It may be found that satisfactory results are obtained by winding the aerial lead-in wire once or twice round the tuning coil of the auxiliary reacting detector stage. Another method is to connect the reacting receiver to a short aerial running in proximity to the aerial of the superhet. A method which has been successfully employed, is to actually link couple by twisted flex feeders, the reacting receiver coil to the aerial coil of the superhet. As many readers will no doubt own a reacting detector type of short-wave receiver of some description, they will no doubt be able to experiment for themselves with an auxiliary reaction stage. In some

cases a very appreciable increase in sensitivity can be obtained, and the simplicity of the arrangement, in those cases where a reacting detector receiver is available, has much to commend it.

Application of regeneration to the I.F. stages of a superhet, is inclined to be tricky. By winding an insulated wire closely round the grid terminal of the I.F. amplifying valve, and poking the other end through one of the holes in the top of the I.F. transformer following the I.F. valve, it is possible to cause regeneration through the capacity feedback from anode to grid. If this is tried, however, care should be taken that the wire is really and truly insulated, and does not make contact with either the valve cap, or anything inside the I.F. transformer!

Another method that the writer has seen described, is somewhat ingenious, and is illustrated in Fig. 3. The screen bypass condenser of the I.F.

valve is disconnected at the earth side, and a variable resistance of, say, 25,000 ohms inserted. When the resistance is set at zero, everything is as before, but as the resistance is increased, the bypassing action of the condenser is impaired, with the result that stray feedback effects produce regeneration. The I.F. stage may even be made to oscillate, and thus allow of C.W. reception without the usual type of beat oscillator. This method, however, does involve actual alteration to the wiring of the receiver, which may not always be practicable in the case of commercial receivers.

It is hoped that this article, and the preceding one, will have provided readers with material for experiments that will enable them to not only provide improved reception but also further interest in the subject of S.W. reception.

"The Photo-Augetron"

(Continued from page 76)

opening being usually about 1 in. in diameter, but for special uses various cathodes of the metal support type have been developed.

Vacuum Science Products, Ltd., have demonstrated several interesting and novel applications of the photo-electron Augetron multiplier. A film gramophone equipment, in which the light from an exciter lamp, after passing through a suitable slit and through the sound track of the special sound film strip, was caused to fall on to the photocathode of a photo-Augetron, and thence to a substantial power amplifier. Troubles ordinarily due to valve noise and poor frequency response were non-existent.

Speech Modulation

Another interesting demonstration involved the transmission of good quality speech and music through the medium of a modulated light beam. A radio set tuned to a local station served to modulate at audio frequency a special type of neon lamp. The focused light beam from this lamp was caused to fall upon the photo cathode of a photo-Augetron, and the output from this was fed directly on to the grid or power valve with a loud speaker. The results were very satisfactory indeed.

It is hoped in a later issue to describe some other specialised electronic equipment involving novel uses of photo-Augetrons. In the meantime, engineers at Vacuum Science Products are making further investigations into the behaviour of grid-controlled thermionic augetrons at high frequencies and it is hoped to describe some of the results of their work in the near future.

The Television Society

The Council of the Television Society have decided to open the headquarters at 17 Featherstone Buildings, London, W.C.1, on Saturday afternoons from 2.30 to 6.30 until further notice. It is hoped that members will take advantage of this opportunity to renew their contact with fellow workers in television and thus keep up their interest in the subject.

Prospective members and visitors are welcome at headquarters provided that due notice is given to the Lecture Secretary, G. Parr, 68 Compton Road, London, N.21.

A Free Manual

The fact that public address, or as it is commonly called, "P.A.," can be made to reproduce music with a fidelity equal to that of a first-class radio receiver seems to be little appreciated even by those actively engaged in the radio industry, and it is certainly the impression that only the most expensive apparatus is capable of giving truly realistic reproduction.

This erroneous idea would be dispelled if all radio engineers engaged in making up P.A. equipment would study Mr. Partridge's booklet on the subject. As stated in the preface, Mr. Partridge not only has the experience in radio circuits, but is a first-class musician and is thus able to appreciate the meaning of the words "high fidelity."

It has been said before that the per-

formance of an amplifier is no better than that of the output transformer, and the transformer characteristics given in the book show that by proper design and attention to the construction there need be no limitation to the quality so far as this component is concerned.

Mr. Partridge has arranged to supply copies of the book *free* to readers of this journal and they are urged to write as soon as possible and obtain one. Mention of this journal should be made. His address is: N. Partridge, Esq., B.Sc., King's Buildings, Dean Stanley Street, S.W.1. A companion booklet to the above is also available on Amplifier Circuits, price 2s. net, and this carries the offer of free technical information on any of the circuits described.

It is rather surprising that a large number of short-wave listeners who are anxious to bring in as many stations as possible do not appreciate the value of using a sensitive pair of phones instead of depending for their tuning on a loudspeaker. The increased sensitivity of phones makes an amazing difference to the number of stations which can be intelligibly received, and from experience we have found that by using a really good pair an increased "bag" of more than 30 per cent. is often possible.

We have relied on Ericsson phones for many years. For quality of reproduction and sensitivity they are excellent. An instance of their high sensitivity was given a few weeks ago when tuning to some of the lesser known stations in our Short-wave Guide (which readers will remember appeared in the December issue); stations which were too weak to be distinguished with any degree of certainty on the speaker could be heard with ease on these phones.

Please ask your bookstall or newsagent to reserve a copy of **ELECTRONICS AND TELEVISION & Short-wave World** each month and avoid disappointment.

A RECORD OF PATENTS AND PROGRESS

RECENT DEVELOPMENTS

PATENTEES

Foster Instrument Co., Ltd., and A. Douglas :: Marconi's Wireless Telegraph Co., Ltd. :: Electrical Research Products Inc., :: W. Ehrenberg and S. Hill :: W. W. Triggs (Kansas City Testing Laboratory) :: F. W. Cackett :: C. L. Fadell, R. E. Spencer and J. P. James :: L. Klatzow :: Lodge-Cottrell Ltd.

Heat-sensitive Relays
(Patent No. 506,596.)

When making a quantitative measurement of the heat radiated by a given body, it is necessary to make allowance for what may be called ambient changes in the temperature of the air, due, say, to convection currents and other causes.

it is capable of handling a heavy power output.

A straight indirectly-heated cathode C is enclosed in a cylindrical anode A, which is fitted with a screen-covered aperture S in order to allow the passage of helium gas between the interior of the anode and the rest of the glass bulb B. Another screened

Normally, a voltage less than that required to ionise the gas exists between the main cathode and the anode. The input or control voltage is applied between the grid G₁ and cathode C₁, the resulting output current being drawn off between the main cathode C and the anode A.—Marconi's Wireless Telegraph Co., Ltd.

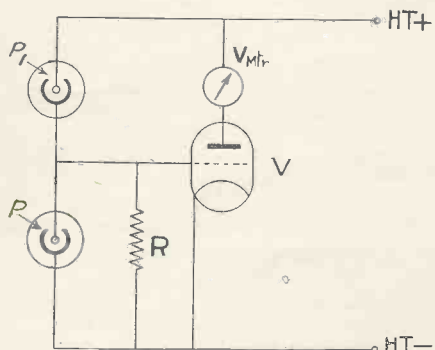

Circuit for measurement of heat radiation. Patent No. 506,596.

The circuit shown is designed for this purpose. It consists of two photo-electric cells P, P₁ arranged in opposition (i.e., the anode of one is connected to the cathode of the other) across the grid of an amplifier valve V. The anode circuit of the valve V includes the measuring instrument M.

The radiation to be measured is allowed to fall only upon the sensitive cell P₁. Any change in the ambient temperature affects both cells equally, so that the resulting "dark" currents automatically balance out on the grid of the amplifier V. The indication recorded by the meter M will therefore be that due to the radiated heat alone.—Foster Instrument Co., Ltd., and A. Douglas.

Electronic Relays
(Patent No. 513,652.)

The figure shows the construction of a gas-filled relay tube which is designed to be operated with a comparatively low anode voltage, and to maintain continuous grid control, though

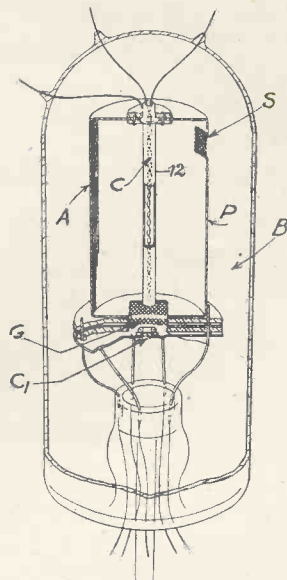

Above: Gas-filled relay tube. Patent No. 513,652.

Right: Electron multiplier. Patent No. 505,663.

aperture S₁, which acts as an auxiliary anode, is arranged around the lower end of the cathode.

An auxiliary cathode C₁ fitted with a disc-shaped grid G projects electrons through the anode-aperture S₁ into the space surrounding the main cathode C in order to neutralise the space-charge which is set up during the operation of the relay tube.

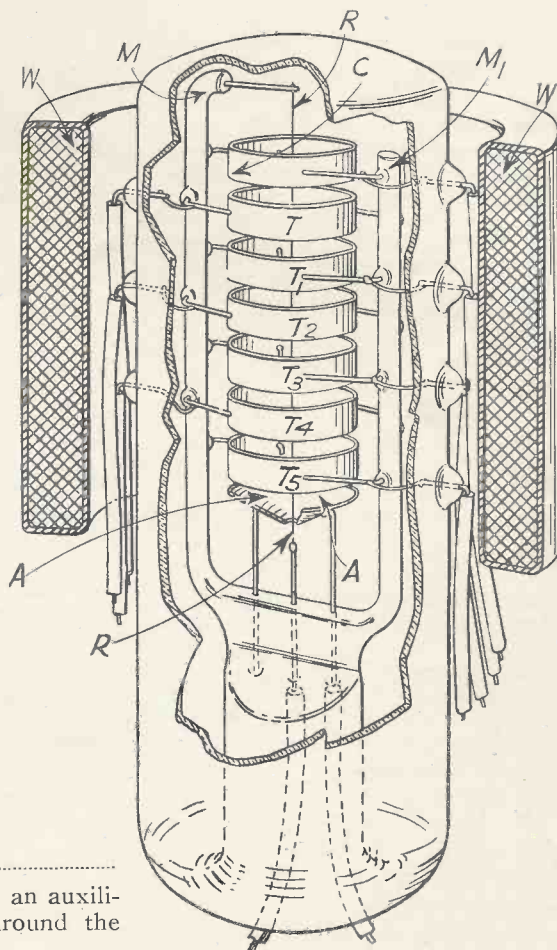

Electron Multipliers
(Patent No. 505,663.)

The drawing shows the electrode construction and assembly of an amplifying tube of the multiplier type. The electrodes consist of a primary

The information and illustrations on this page are given with permission of the controller of H.M. Stationery Office.

cathode C and a series of secondary-emission or target electrodes T - T₅, all arranged concentrically around a central accelerating rod or wire R carrying a high positive potential. The output current is collected by a dish-shaped anode A. The whole assembly is mounted on two upright supports M, M₁ springing from the stub of the tube. An external winding W applies a magnetic field along the axis of the tube.

Electrons released from the cathode C are forced, by the combined effect of the static field from the central rod R and the magnetic field from the winding W, to strike in turn against the inner surface of each of the ring "targets" T - T₅, amplifying themselves at each impact by a factor of the order of eight. The multiplied stream is finally collected by the anode A.—*Electrical Research Products Inc.*

Cathode-ray Tubes (Patent No. 506,704.)

It is common practice to cover part of the inner wall of a cathode-ray tube with a thin coating of silver, which either forms part of the anode of the tube, or otherwise acts as part of the electron-optical system used to focus the electron stream. But such an internal layer of silver must be blackened, in order to prevent any undesirable reflection of light, and this involves a somewhat lengthy and expensive process.

According to the invention, the continuous layer of silver is replaced by a series of fine parallel lines, forming a kind of squirrel-cage arrangement, extending for the desired distance from the anode end of the tube. The lines are of liquid gold painted on the glass wall, and are joined together at both ends by a painted ring of similar material. The external wall of the C.R. tube is covered with a coat of black lacquer.—*W. Ehrenberg and S. Hill.*

Infra-red Television (Patent No. 506,873.)

It is known that infra-red rays (which are too low in frequency to affect the eye directly) will penetrate fog, haze, or mist much more effectively than the shorter waves which fall within the visible spectrum. This property can therefore be utilised to enable objects normally obscured from sight to be made visible by television.

According to the invention, the infra-red rays are focused upon the mosaic-cell screen of a television transmitter of the Iconoscope type,

and are scanned, in the usual way, to produce television signals, which are then applied directly to a television receiver so that they are made visible on the fluorescent screen. In the circuit described, the scanning voltages for both tubes are supplied from a common source, so as to simplify synchronisation. Means are also provided to transform the inverted image produced on the mosaic screen into an erect image as viewed on the fluorescent screen.—*W. W. Triggs (Kansas City Testing Laboratory).*

Electron Optics (Patent No. 512,933.)

Electrons from a cathode K are accelerated by a grid G and formed into a beam by the electrodes A, B. The

out having to be passed through a filter circuit.

The required result is obtained by feeding the mixed signals to the grid of the triode section of a triode-hexode valve, and feeding-back the two impulses from the anode of the triode, through a resistance-capacity link, to the control-grid of the hexode section of the valve. The triode grid is directly connected to the "inner" grid of the hexode section, and the output, which is taken across the anode and cathode of the hexode section, will then contain the line impulses at one amplitude and the framing impulses at a greater amplitude.—*C. L. Fadell, R. E. Spencer and J. P. James.*

Improving electron beam focus. Patent No. 512,933.

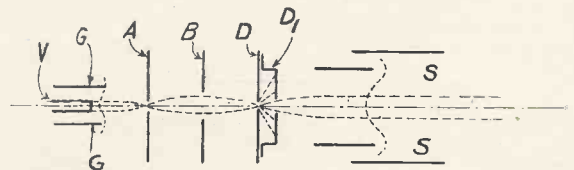

beam passes through an apertured diaphragm D where the resulting contact usually tends to produce secondary electrons. These are given off at different velocities to that of the primary stream, and so cannot be brought to the same focus as the latter by the voltages applied to the subsequent control electrodes. In consequence they produce a certain amount of distortion on the fluorescent screen.

According to the invention, a dish-shaped electrode D₁ is mounted over the aperture of the diaphragm D and serves to collect the secondary electrons, as shown in dotted lines, leaving only those electrons which travel forward at the same speed to pass through the subsequent focusing-system S on to the fluorescent screen of the tube.—*F. W. Cackett.*

Time-base Circuits (Patent No. 513,205.)

Relates to a method of separating the framing impulses from the line impulses in a television receiver. The two sets of impulses are transmitted with the same amplitude but of different duration, the framing impulses being the longer. Both are superposed on the carrier wave in the opposite sense to the picture signals.

The object of the invention is to transform the difference of duration between the frame and line impulses into a corresponding difference of amplitude, so that each impulse can be applied directly to trigger its separate saw-toothed oscillator, with-

Light-sensitive Materials

(Patent No. 513,523.)

A light-sensitive material suitable for photo-electric cells, or for television transmitters of the cathode-ray type, or for electron microscopes, light-transformers, and the like, is made from a compound of antimony and palladium treated with caesium. The colour response of the compound is similar to that of the human eye, except that it is more sensitive to the blue end of the spectrum.—*L. Klatzow.*

Precipitating Dust by Ionisation

(Patent No. 506,896.)

A gaseous fluid is filtered or freed from particles of dust, or other suspended impurities, by passing it through a chamber containing a series of oppositely-charged vanes or electrodes, with sharp edges to facilitate the production of electric discharges between them. The vanes are set criss-cross and help to guide the gas as it is drawn through the chamber, the direction of the electric field being substantially parallel to the path of the gas.

This produces a strong ionisation, and a corresponding thorough precipitation of the suspended particles of dust on the collecting vanes or electrodes. Either alternating or direct current may be used to produce the discharges.—*Lodge-Cottrell, Ltd.*

"Construction of Apparatus for Recording Sound on Steel Wire."

(Continued from page 74)

posed spring arm of the switch which could not be earthed.

No doubt other methods can be devised to meet any such problems which may arise, but in general all grid leads should be screened and earthed, this applying also especially to the leads from the head and the microphone leads. Grid condensers, volume control, etc., should not be too close to the output transformer. A fuse should be fitted in the H.T. negative lead otherwise expensive valves may be blown.

The H.T. supply should be from H.T. accumulators or triple-capacity dry batteries on account of the momentary high H.T. current taken by a quiescent push-pull circuit on loud passages. The low tension should be of fairly large capacity for consistent results and to supply the wipe-out current. The wipe-out variable resistance of about 15 ohms total resistance is also mounted on the front panel, but the two-way switch for bringing it in circuit when necessary is mounted on the baseboard of the machine to avoid further unshielded grid extensions crowded behind the amplifier panel. No doubt with a little further experiment it would be possible to combine the move-

ment of the resistance and the two-way switch in one operation on the baseboard of the machine. As the wipe-out current is never likely to exceed one ampere this resistance wire need not be of heavy gauge.

Special provision in the tone control for accentuating the high notes when recording should be made. It was found that the usual tone control and background filter as seen at B in Fig. 8, although essential for playing back, when left in circuit for recording tended to suppress or muffle the high notes even when in the "high note" position, or with different values of condensers and resistances. By providing a small two-way switch connected as shown at A Fig. 8, the tone control is cut out entirely for recording and the high notes by-passed by a small condenser at C². This somewhat upsets the smooth progressive control of the volume control, but the correct point having once been found on the dial and noted, it remains constant for all subsequent recordings.

In this respect it will be found that the best plan is to record always at the same setting on the dial of the volume control, and actually only to control the volume on the play back at whatever strength suits the listeners.

The setting for recording should be that point on the volume control which gives the loudest recording consistent with good quality. It will then be found that, all other factors being correct, on playing back all out, the volume will be so great that it will be necessary to cut it down, when any slight background that may be present will be eliminated. If, on the other hand, a weak recording is made, the play back may have to be played all out, when the slight background hiss may become evident. This will be understood when it is seen that no background hiss is impressed on the wire when recording, irrespective of the recording strength, but emanates entirely from the playing-back conditions.

For playing back the switch A converts conditions to normal tone control with smooth volume control. Unfortunately this switching action could not be incorporated in the main switch because of the feed back difficulty, but it is easily operated.

It is realised that this arrangement is somewhat unusual but it was arrived at after a great deal of experiment and solved the problem of obtaining perfect quality in this case, although it may be found that different measures are necessary to meet special conditions, such as the type of microphone used, which appears to be the main factor in determining the high note response.

It will be noted that one of the "head" leads is also earthed, since this was found to diminish considerably any stray electrical or magnetic influence picked up by the "head."

It was found that a steel case for the amplifier, although earthed, tended to increase rather than decrease such interference, so a wooden case was made. This interference ceased on moving the amplifier (with the steel case) a considerable distance from the machine and was no doubt due to the magnetic field of the motor. This, however, necessitated long leads to the machine, which was undesirable, so the wooden case is retained, the amplifier being placed some three feet from the machine.

With the class B output shown, the moving coil speaker must, of course, have its own step-down transformer and a small fixed condenser of about 0.1 mfd. across the primary may be found to improve the quality.

The drum and guide pulley which are mechanically the more accurate and truer of the pair should be made to drive the drum for recording and playing-back. Of course, it does not make any difference which side it is, but having made a choice it should be adhered to, otherwise much confusion in operation may arise. See that the drum discs (if built up) are a good flush tight fit at the bottom of the groove otherwise the wire will bind in it.

(Next month: "Using the Apparatus—Recording and Playing.")

BINDING CASES AND INDEXES FOR 1939

Binding cases and indexes for the 1939 volume of this journal are now available. The cases are full brown cloth with stiff boards lettered in gold.

The price, including the index, is 2/9 post free.

Indexes may be obtained separately price 6d. post free.

Orders should be addressed to the Editorial Offices of the journal at
CHANSITOR HOUSE,
37-8, Chancery Lane, London, W.C.2

and should be accompanied by the remittance.

VACUUM SCIENCE PRODUCTS LIMITED

Bosch Electronics

St. George's Works,
Merton Road, Norwood Junction,
London, S.E.25

Telephone: ADDiscombe 4529

★★

Thermionic Augetrons

£3 . 3 . 0

Photo Augetrons 6 stage

£5 . 5 . 0

amplifier can be markedly affected by the presence of a grid-bias resistor in the cathode circuit (self-bias), if this resistor is not adequately by-passed.

For most of the stages the requisite value of by-pass condenser was impracticably high. Hence, fixed bias was employed by using a small 150-volt regulated power unit, and reducing the voltage to the desired bias value for each stage by means of individual resistance voltage dividers. The individual voltage dividers, together with the regulated voltage source, prevented common coupling between the various grids.

For the first stage, however, self-bias was deemed more advisable since it permitted a much higher grid resistance to be employed, and, hence, a smaller coupling condenser. These reduce the loading on a source, such as the attenuator, both at low and high frequencies.

The common self-bias resistance in the final push-pull stage made low-frequency adjustments difficult in that the 807 fed from the anode side of the inverter required careful adjustment of its input circuit in order that a distorted square-wave voltage would not be developed across the bias resistance. (The low value of 75 ohms made by-passing impracticable. Such a distorted voltage would react on the other 807 grid to distort this side, too, even if the normal voltage input from the

cathode side of the inverter was undistorted. By careful adjustment of the grid resistances and build-up circuit, and by observation of the results directly on the oscilloscope screen, a satisfactory 30-cycle square wave was obtained.

In a system whose response goes up so far in the frequency spectrum, it is to be expected that commercial condensers should cease to be effective, and it was found necessary to shunt the 8-mfd. condensers with 0.1 mfd. paper condensers and these in turn with 0.004 μ f mica condensers. Each unit of the parallel grouping thus affords by-passing over a suitable overlapping portion of the spectrum, and so low is the Q of a condenser in the range where it acts as an inductance that no resistive de-coupling between the units was found necessary to prevent parallel resonance with consequent lack of by-passing. A further advantage is that only the small by-pass condensers need be located close to the valve in the shield can. On the other hand, no advantage was noted when mica condensers were shunted across the grid-coupling paper condensers, and so the former were omitted here.

The earthing for each stage presented some difficulty, since stray currents of very high frequency can cause instability in the amplifier. All earthed ends of the units in a stage were connected to one point in the stage-

shield can to prevent current flow in the copper chassis. The only (unavoidable) earth current was that flowing into the input admittance of the following stage (grid capacity to earth) and this effect was not apparently appreciable.

War-time Radio Developments

ALTHOUGH since the outbreak of war there has been very great activity in the development of radio equipment in England, for the most part this activity is carried out in secret and no reports of discoveries or developments actually reach the average person. In America, of course, amateur and commercial radio is proceeding at its usual pace.

Perhaps the most interesting recent releases are in the ultra-high frequency field and a new receiver by Hallicrafters is bound to set a higher standard than ever for long-distance accurate U.H.F. work. This instrument covers the continuous frequency range from 27 to 150 Mc.; employs three Acorn type tubes, the third being a triode oscillator, and a Dickert noise silencer unit. Three intermediate stages, using the new 6SK7 tubes, with an I.F. frequency of 5.25 Mc., assure a very high gain and stable performance. Another outstanding feature, and one which we

(Continued opposite)

KHAKI AND BLUE!

The Incorporated Radio Society of Great Britain is proud to announce that more than 500 of its members are serving in Signal Branches of the Army, Navy and Air Force. The importance to the Nation of the radio amateur in war time has thus been amply demonstrated.



To-day with hundreds of young men on the verge of a call to arms it is more than ever essential that they should endeavour to fit themselves for the task ahead.

THE T. & R. BULLETIN (Official Journal of the Society) provides an invaluable means of keeping abreast with radio developments at home and abroad.

AN INVITATION

If you are not a member of the Society you are invited to send 1/- for a copy of the current issue of *The T. & R. Bulletin*, which contains important contributions on Frequency Meters, Ultra-High Frequency Receivers, Frequency Modulation, Accumulator Charging, etc. In addition, topical articles deal with conditions on various amateur frequencies.

THE AMATEUR RADIO HANDBOOK

Over seven thousand copies of the first edition of this 300-page standard British text book have been sold. The 25 Chapters cover every phase of short-wave work.

Single copies, 3/- post free.

Overseas, 3/6 post free.

Quotations for quantities.

REDUCED WAR TIME SUBSCRIPTION RATES

Home Members ...	15/- p.a.
Service Members ...	10/- p.a.
Overseas Members	12/6 p.a.

All communications to:—The Secretary-Editor.

RADIO SOCIETY OF GREAT BRITAIN

16, Ashridge Gardens, Palmers Green, N.13

Telephone, Palmers Green 3255

THE TELEVISION SOCIETY AND THE WAR

Now that the war has put a temporary stop to television developments, it is more than ever necessary that the work of the Society should continue.

At its new headquarters at 17, Featherstone Buildings, Holborn, a reference library of books and data is available to members, and a museum of historic apparatus is in course of assembly.

This will form a valuable record of work done in the television field, and will enable all interested in the science to keep track of the progress made until normal working is resumed.

Television engineers are invited to register with the Society, who will be pleased to put them in touch with fellow workers and keep them informed through the medium of the Journal.

Full particulars of membership qualifications may be had from the Hon. General Secretary:—J. J. Denton, 17, Anerley Station Road, London, S.E.20.

THE TELEVISION SOCIETY

(Founded 1927)

President: Sir AMBROSE FLEMING, M.A., D.Sc., F.R.S.

OPPORTUNITIES SECTION

BUSINESS :: EQUIPMENT :: EMPLOYMENT :: MISCELLANEOUS

The charge for miscellaneous advertisements on this page is 12 words or less 2/-, and 2d. for every additional word. Single-column inch rate displayed, 12/6. All advertisements must be accompanied by remittance. Cheques and Postal Orders should be made payable to Bernard Jones Publications Ltd., and crossed, and should reach this office not later than the 15th of the month previous to date of issue.

"War-time Developments"

(Continued from page 96).

believe to be incorporated for the first time in this model, is *Frequency Modulation Reception* on all wavebands. Up to the present very little has been done with frequency modulation in this country, but it is definitely on the way and we are confident that it will not be long before it is placed on a practical and useable basis. The sensitivity of the instrument is given as 5 microvolts or better for 50 Mw. output, whilst the band width is stated to be 75 Kc. at 100 times down.

The first delivery of this new model S-26 is due in this country at the end of February, the first consignment having already left the Chicago works. The price is not yet fixed.

Another new Hallicrafter instrument, which is already available in this country, is a new version of the very popular "Champion" S-20, of which Webb's Radio have sold many hundreds to amateurs and commercial bodies for general short-wave reception. The new model, the S-20R, differs from the original by the incorporation of an additional stage of I.F., a Dickert noise limiter and a new calibrated and illuminated dial similar to the SX-24. The price of this new model is £18 2s. 6d.

Besides complete receivers there are also many small items and new radio valves which are bound to be of interest to the experimenter and electronic engineer. A range of highly sensitive relays manufactured by the Sigma Instruments, of Massachusetts, is proving popular with Government departments.

Some difficulty may have been experienced in obtaining some of the American valves. Webb's have, however, enormous stocks and their storerooms reveal the following interesting figures: Over two thousand RCA Acorns, types

INDEX TO ADVERTISERS

	PAGE
A.C.S. Radio	90
Automatic Coil Winder & Electrical Equipment Co., Ltd.	Cover ii
British Institute of Eng. Technology	Cover iii
British Mechanical Productions, Ltd.	93
British Tungsram Radio Works, Ltd.	84
Bulgin, A. F., & Co., Ltd.	91
Candler System Co.	90
Clix	93
Edison Swan Electric Co., Ltd.	50
Electradix Radio	93
Ericsson Telephones, Ltd.	89
Fluxite, Ltd.	Cover ii
Foyles, Ltd.	Cover iii
Galpins	95
Partridge, N.	93
Peto-Scott Co., Ltd.	93
Premier Radio Co.	85
Quartz Crystal Co., Ltd.	90
Radio Society of Great Britain	96
Radiomart	87
Taylor's Electrical Instruments Ltd.	87
Technological Institute of Gt. Britain	87
Telegraph Construction & Maintenance Co., Ltd.	Cover ii
Television Society, The	96
Universal Electrical Co.	87
Vacuum Science Products Ltd.	86
Webb's Radio	Cover iv, 49

955, 956, 958 and 957; nearly three thousand Raytheon 807 beam power tubes; several thousands of Taylor 866 rectifiers, TZ40, TZ20, etc., and almost ten thousand American receiving tubes of every type.

Before visiting Webb's this month we were rather inclined to the opinion that trade in American radio produce would have suffered a severe set-back owing to the war. We were, however, literally amazed not only at the quantity of equipment moving in and out, but at the extremely varied class of users.

All the latest receivers referred to above are available from Webb's Radio. The address is 14 Soho Street, London, W.1.

FOYLES

BOOKSELLERS TO THE WORLD
New and second-hand books on every subject
113-125 Charing Cross Rd., London, W.C.2
Telephone Gerrard 5660 (16 lines)

MISCELLANEOUS

ALL TYPES of Rotary Converters, electric motors, battery chargers, petrol electric generator sets, etc., in stock, new and second-hand.

A.C.-D.C. Conversion Units for Operating D.C. Receivers from A.C. Mains, 100 watts output, £2. 10: 150 watts output, £3. 10.

WARD, 46, Farringdon St., London, E.C.4. Tel. Holborn 9703.

LOUDSPEAKER repairs, British, American, any make, 24-hour service; moderate prices.—Sinclair Speakers, Pulteney Terrace, Copenhagen Street, N.1.

LOUDSPEAKERS

3,000 SPEAKERS P.M. and energised 4" to 14" including several Epoch 18". Sinclair Speakers, Pulteney Terrace, Copenhagen Street, N.1.

PATENT AND TRADE MARK AGENTS

GEE & CO., patents and trade marks throughout the world (H. T. P. Gee, Mem.R.S.G.B., A.M.I.R.E., etc.), Estab. 1905, 51-52, Chancery Lane, London, W.C.2 (2 doors from Government Patent Office). 'Phone: Holborn 4547 and 4548. Handbook free.

KINGS PATENT AGENCY LTD. (B. T. King, A.I.Mech.E. (2BKT) Patent Agent) 146a, Queen Victoria Street, London, E.C.4. ADVICE, Handbook and Consultations free. 'Phone City 6161.

MORSE EQUIPMENT

FULL RANGE of Transmitting Keys, Practice Sets, Oscillators, Recorders and other Radio Telegraph Apparatus, designed and manufactured by T. R. McElroy, World Champion Telegraphist. Absolutely first-class construction.—Webb's Radio, 14, Soho Street, London, W.1. 'Phone: Gerrard 2089.

COMMUNICATION RECEIVERS

The famous HALLICRAFTER SX23, released by the makers only in July 1939, can still be supplied by Webb's Radio at

PRE-WAR PRICES. We fortunately had good supplies delivered in August. NO price increase on present stock of this model only, £33/10/0. H.P. terms available. Write for descriptive Leaflets. "E." WEBB'S RADIO, 14, Soho St., London, W.1. Phone: Gerrard 2089.

RADIO MAP AND GLOBE

WEBB'S RADIO MAP of the World enables you to locate any station heard. Size 40" by 30". 2-colour heavy Art Paper, 4/6. Limited supply on Linen, 10/6. **WEBB'S RADIO GLOBE**—superb 12" full-colour model. Radio prefixes, zones, etc. Heavy oxidised mount. Post Paid, 27/6.—Webb's Radio, 14, Soho Street, London, W.1. 'Phone: Gerrard 2089.

PUBLIC ADDRESS

"PARTRIDGE P.A. MANUAL," standard handbook on electro-acoustics, amplifiers, and audio circuits; price 2/6 (free to trade).

"PARTRIDGE AMPLIFIER CIRCUITS," describes many modern constructional amplifiers, 2w. to 45w. output, battery, A.C.-D.C., etc.; price 2/- (no free copies).

PARTRIDGE, N., B.Sc., A.M.I.E.E., King's Buildings, Dean Stanley St., London, S.W.1. (0630)

EDUCATIONAL

MORSE CODE COURSES. "Book of Facts" Free.—Candler System Co. (B), 121, Kingsway, Lond on, W.C.2.

TELEVISION.

A NEW COURSE OF INSTRUCTION.

We have pleasure in announcing that our new "Television" Course has met with remarkable success. The enormous demand for the Course has shown, beyond any shadow of doubt, that it fills that long-felt need which we anticipated when we went to such trouble and expense in its preparation.

We shall be happy to send full details of this special "Television" Course on request. Particulars are also available of other Courses in all branches of Wireless, Television, Talking Picture Engineering, etc., and of the easiest way in which to prepare for the A.M.I.E.E., A.M.I.W.T., A.M.I.R.E., etc., Examinations.

We teach by correspondence, and guarantee **"NO PASS—NO FEE."** Our Technical Consultant is Professor A. M. Low.

Send for full particulars to-day. Free and without obligation.

THE BRITISH INSTITUTE OF ENGINEERING TECHNOLOGY
337, SHAKESPEARE HOUSE, 17/19, STRATFORD PLACE
LONDON, W.1.

"Electronics & Television and Short-wave World" will be sent post paid to any part of the world for twelve months for 20/-